



Label printers A⁺ and X series

Made in Germany

Contents

Industrial label printers	3
Label printers A+ series - overview of types	4-5
Label printers with centered material positioning	6-7
Label printers for double-sided printing	8-9
Label printers for two-color printing	10-11
Label printers - technical data	12-13
Accessories - overview	14
Accessories - special equipment, interfaces, connecting cables	15
Accessories - cutting labels, perforating labels, stacking labels	16
Accessories - rewinding labels, unwinding labels	17
Accessories - dispensing labels	18-19
Applicator A1000	20
Accessories - applicator A1000	21
Applicator A3200	22
Accessories - mounting equipment	23
Label software cablabel S3	24
Integration	25
Stand-alone operation, easy maintenance	26
Service, training	27
Label printers - product range	28
Accessories - product range	29-30
cab product range at a glance	31

All information on scopes of delivery, design and technical specifications correspond to the date of the printing. Subject to change.

*For current data see website
www.cab.de/en/labelprinter.*

Industrial label printers



Professional industrial cab label printers are used in a wide variety of applications. Their development is first and foremost focused on simple and convenient operation coupled with high reliability.

Printing units and housings are made of high-quality materials and are perfectly matched in terms of shape and function. Extensive peripherals and software enable customized solutions – at any time.

Regardless of whether the A+ or X printer series is operated as a stand-alone solution, a PC application or in a network, it is always up to the mark. The high-speed processor ensures both fast job processing and immediate label output.

Sample applications:

PCB labels

If there is only little space available – smallest label size 4x4 mm



Type plates

Pin sharp 600 dpi fonts, graphics and barcodes



Cardboard box and pallet labels

Labels up to standard A4 format



Label printers A+ series - overview of types



The sleek one

For **small labels with high printing accuracy**

1.1	Label printer		A2+	
	Printable resolution	dpi	300	600
	Print width	up to mm	54.2	57
	Print speed	up to mm/s	150	100



The all-purpose one

Top-selling **industrial device with high printing accuracy**. Extensive range of accessories included.

1.2	Label printer		A4+	
	Printable resolution	dpi	203	300
	Print width	up to mm	104	105.6
	Print speed	up to mm/s	250	100



The wide one

Ideal for **Odette and UCC labels**

1.3	Label printer		A6+	
	Printable resolution	dpi	203	300
	Print width	up to mm	168	162.6
	Print speed	up to mm/s	200	200



The extra wide one

For **pallet and barrel labels**

1.4	Label printer		A8+
	Printable resolution	dpi	300
	Print width	up to mm	216
	Print speed	up to mm/s	150



Basic version

For printing on labels and continuous materials. The material is torn off at the jagged tear-off edge. Optionally, it may be cut or rewound externally.



Dispensing version

For printing and dispensing labels. The label is removed from the liner during the printing process. It can be removed manually, by applicator or robot.

Common details



Pictured:
Label printer A4+
with dispensing function

- 1 Wide graphic display**
White backlight for optimum readability.
- 2 Ribbon holder**
Three-part tightening axles enable a quick and easy exchange of ribbons.
- 3 Simple adjustment**
The print head is pressed down by two toggles. One is mounted to the left label margin, the other is pushed to the right label margin.
- 4 Peripheral connection**
All add-on modules are easy to connect. All peripheral devices are plugged in the printer using two pins and are fixed in place with a screw.
- 5 Solid metal housing**
Die-cast aluminum. All components are mounted on it.
- 6 Roll holder**
Available for core diameters starting 38 mm (76 mm adapters for improved label winding are provided). The spring-mounted margin stop ensures constant tension during feeding, thus ensuring high printing accuracy.
- 7 Internal rewinder**
The rewinder with a three-part tightening axle ensures easy rewinding and removing of labels or liners with or without paper core.
- 8 Peel-off function**
The label is removed from its liner via peel-off plate. High printing and dispensing accuracy can be achieved via powered rewind assist and pinch rollers.

Compact cover



The two-part cover made of impact-resistant ABS plastic folds up when opened.

1.11 Metal cover



On request, label printers A4+ and A6+ are available with metal cover (standard with the A8+).

Label printers with centered material positioning



All materials that are wound on **rolls** or **reels** can be marked. Especially **very small labels** and **slim continuous materials** such as pressed tubes.

- No adjustment of print head for different widths of material
- Print rollers for narrow and slim materials
- Operation and control are compatible with the A+ series

1.5	Label printer		A4+M	
	Printable resolution	dpi	300	600
	Print width	up to mm	105.6	105.6
	Print speed	up to mm/s	125	100



All materials that are wound on **rolls** or **reels** can be marked. Particularly for **textile materials** there is a drive roller installed next to the print head. It enables the textile material to be separated from the ribbon and furthermore improves the accuracy and precision in a print.

- No adjustment of print head for different widths of material
- Print rollers for narrow and slim materials
- Operation and control are compatible with the A+ series

1.7	Label printer		A4+T	
	Printable resolution	dpi	300	600
	Print width	up to mm	105.6	105.6
	Print speed	up to mm/s	125	100

Accessories



Cutter

Used to cut paper labels, self-adhesive labels, cardboard, textile or synthetic materials as well as heat shrink tubes.

Perforation cutter

Enables the perforation of the material for later manual separation.



Stacker with cutter

Printed materials are cut and stacked. The print job is stopped as soon as the maximum stack height is reached. Even stiff or curved materials may be processed. We recommend to have your material tested at our facilities.

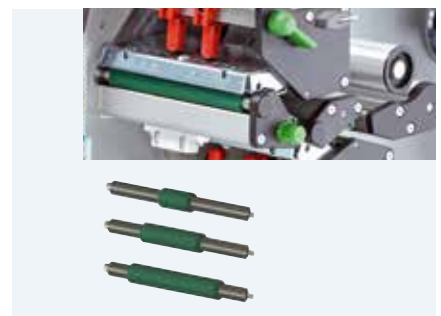

Print rollers for small and thin materials

Outside the material width the print head rubs against the print rollers. By using small print rollers feeding errors and wear on print head and print roller due to rubbing are avoided. Three different standard widths are available from stock.

Common details



Pictured:
Label printer A4+M
with centered material positioning

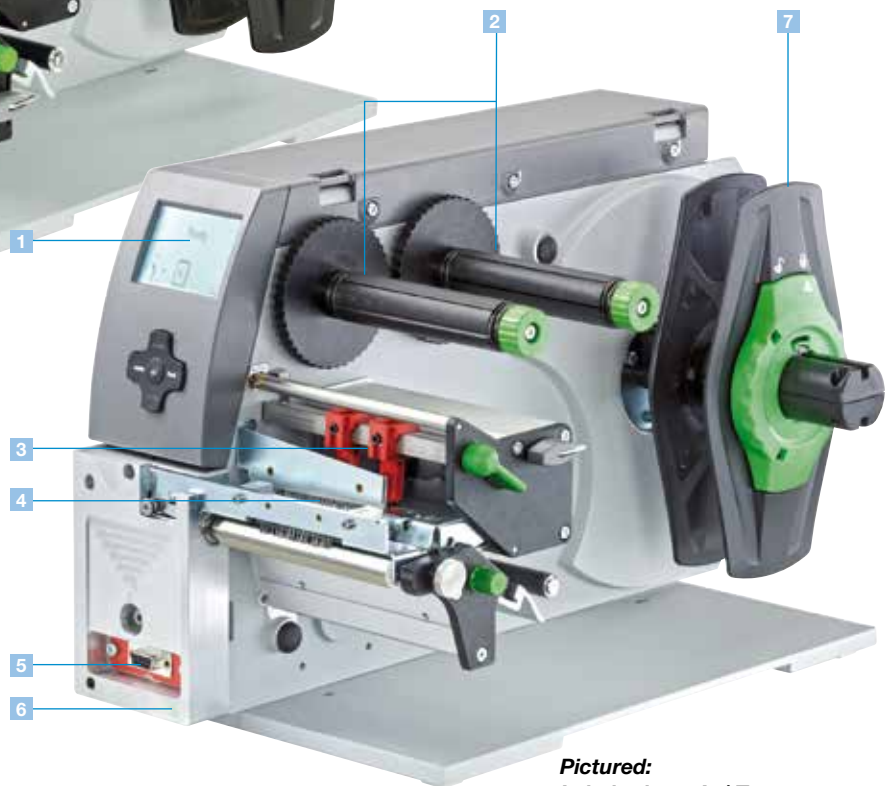

Pictured:
Label printer A4+T
with centered material positioning

1 Wide graphic display

White backlight for optimum readability.

2 Ribbon holder

Simple, centered insertion of the ribbon with three-part tightening axles. Imprinted rule simplifies ribbon positioning.

3 No print head adjustment

The print head is pressed down by two toggles. Due to centered material positioning there is no need to do print head adjustments and settings.

4 Material positioning

High printing accuracy as the material is located directly behind the print roller. Width adjustment with a single knob.

5 Peripheral connection

Add-on modules such as cutter, perforation cutter and stacker are easy to connect.

6 Solid metal housing

Die-cast aluminum. All components are mounted on it.

7 Roll holder

Available for core diameters starting 38 mm (76 mm adapters for improved label winding are provided). The material is automatically centered. The spring-mounted margin stop ensures constant tension during feeding, thus ensuring high printing accuracy.

Label printers for double-sided printing



It prints double-sided on **textile materials, cardboard labels, pressed tubes**, continuous or ready-for-use, as well as on **continuous synthetic, paper or cardboard materials**. A drive roller enables the materials to be separated from the ribbon and furthermore improves the accuracy and precision in a print.

- No adjustment of print head for different widths of material
- Print rollers for narrow and slim materials
- Operation and control are compatible with the A+ series

1.8	Label printer		XD4T
	Printable resolution	dpi	300
	Print width	up to mm	105.6
	Print speed	up to mm/s	125

Accessories



Cutter

Used to cut paper labels, self-adhesive labels, cardboard, textile or synthetic materials as well as heat shrink tubes.

Perforation cutter

Enables the perforation of the material for later manual separation.



Stacker with cutter

Printed materials are cut and stacked. The print job is stopped as soon as the maximum stack height is reached. Even stiff or curved materials may be processed. We recommend to have your material tested at our facilities.

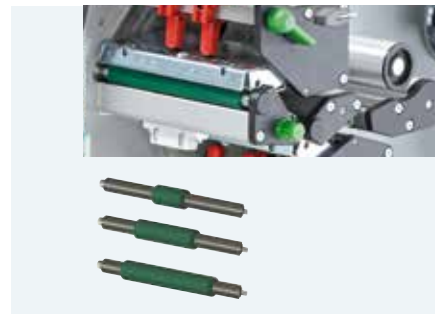

Print rollers for small and thin materials

Outside the material width the printhead rubs against the print rollers. By using small print rollers feeding errors and wear on print head and print roller due to rubbing are avoided. Three different standard widths are available from stock.

Details

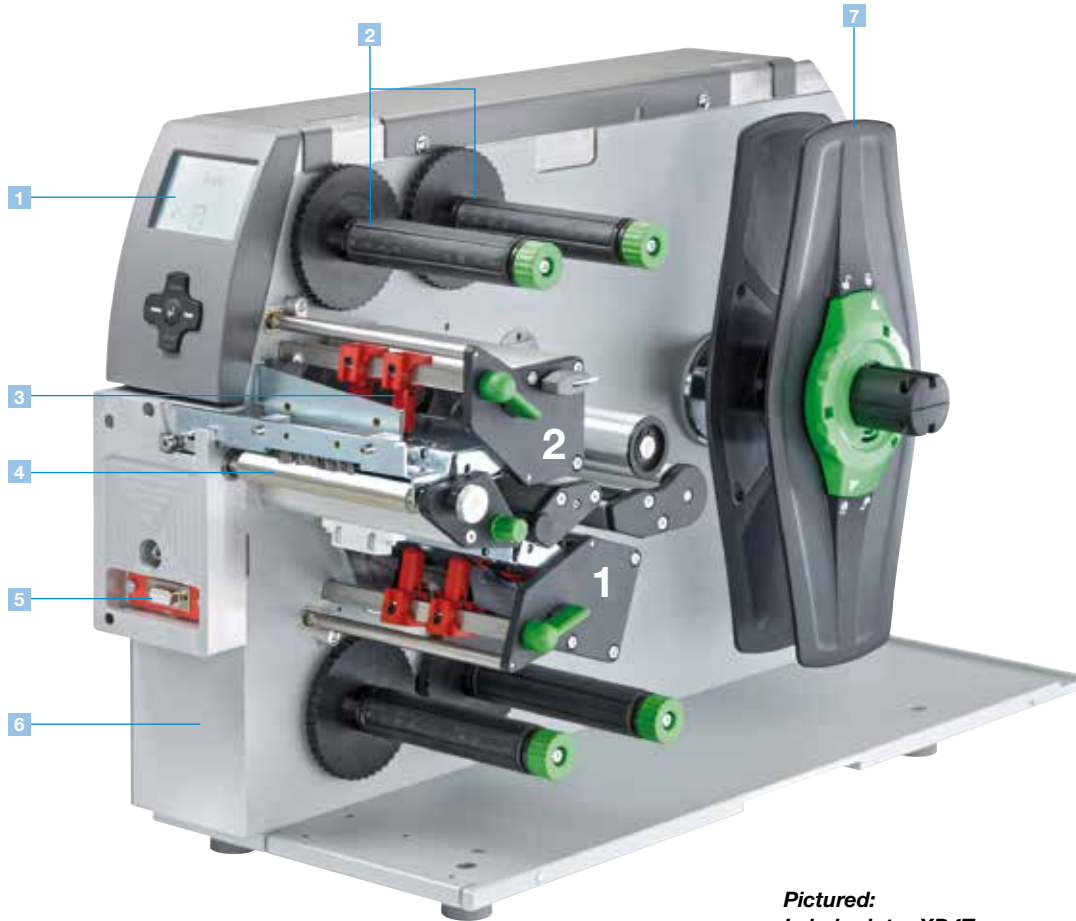

***Pictured:
Label printer XD4T
for double-sided printing***

1 Wide graphic display

White backlight for optimum readability.

2 Ribbon holder

Simple, centered insertion of the ribbon with three-part tightening axles. Imprinted rule simplifies ribbon positioning.

3 No print head adjustment

The print head is pressed down by two toggles. Due to centered material positioning there is no need to do print head adjustments and settings.

4 Material positioning

High printing accuracy as the material positioning is located directly behind the print roller. Width adjustment with a single knob. The additional drive roller enables the material to be separated from the ribbon.

5 Peripheral connection

Add-on modules such as cutter, perforation cutter and stacker are easy to connect.

6 Solid metal housing

Die-cast aluminum. All components are mounted on it.

7 Roll holder

Available for core diameters starting 38 mm (76 mm adapters for improved label winding are provided). The material is automatically centered. The spring-mounted margin stop ensures constant tension during feeding, thus ensuring high printing accuracy.

Label printers for two-color printing



Two in-line arranged thermal transfer print units for **simultaneous two-color printing** in one label. With ribbon saver at one print unit.

- The XC series meets the conditions for the classification and labeling inventory according to GHS.
- For large label rolls up to 300 mm diameter
- The two print units including ribbon holder, operation panel and electronics are adopted from the proven A+ series.

1.9	Label printer		XC4
	Printable resolution	dpi	300
	Print width	up to mm	105.6
	Print speed	up to mm/s	125



1.10	Label printer		XC6
	Printable resolution	dpi	300
	Print width	up to mm	162.6
	Print speed	up to mm/s	125

We are glad to assist you in the selection of proper ribbons.

Accessories



Cutter

Used to cut paper labels, self-adhesive labels, cardboard, textile or synthetic materials as well as heat shrink tubes.

Perforation cutter

For XC4 printers only. Enables the perforation of the material for later manual separation.



Stacker with cutter

For XC4 printers only. Printed materials are cut and stacked. The print job is stopped as soon as the maximum stack height is reached. Even stiff or curved materials may be processed. We recommend to have your material tested at our facilities.

Common details

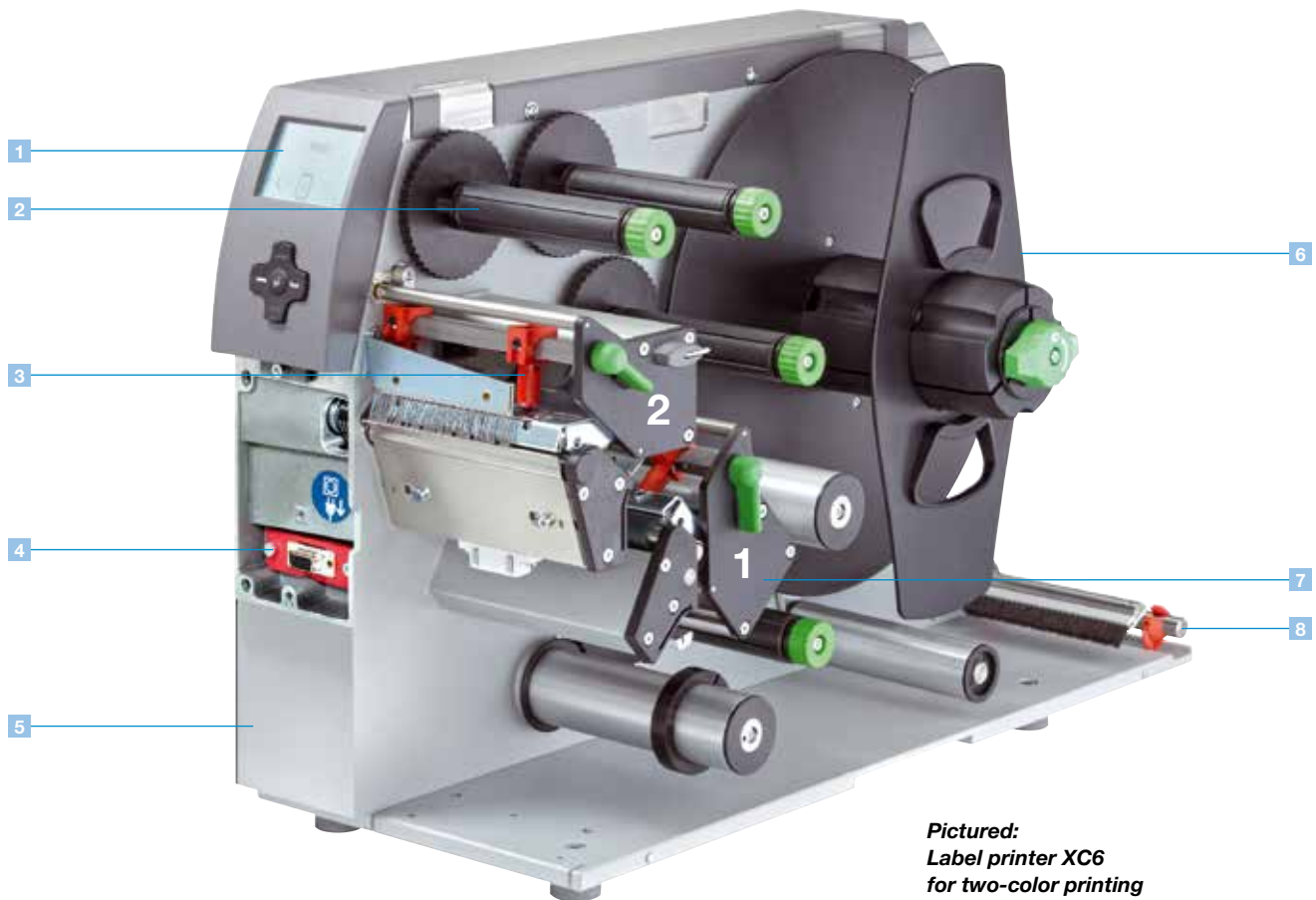

***Pictured:
Label printer XC6
for two-color printing***

1 Wide graphic display

White backlight for optimum readability.

2 Ribbon holder

Simple, centered insertion of the ribbon with three-part tightening axles.

3 Simple adjustment

The print head is pressed down by toggles. One is mounted to the left label margin, the other is pushed to the right label margin.

4 Peripheral connection

All add-on modules are easy to connect. All peripheral devices are plugged in the printer using two pins and are fixed in place with a screw.

5 Solid metal housing

Die-cast aluminum. All components are mounted on it.

6 Roll holder

For labels up to 300 mm diameter. Swing lever and integrated brake make sure that the labels are unwound with constant tension.

7 Ribbon saver for print head 1

The ribbon saver is used for labels to be partially printed. The print head is lifted within the unprinted area and the ribbon stopped during label feeding.

8 Fanfold guide

Fanfolded labels are positioned behind the print unit. Guide and additional brake ensure reliable feeding to the print unit.

Label printers - technical data

■ Standard □ Optionally

	1.1	1.2	1.3	1.4	1.5	1.7	1.8	1.9	1.10							
Label printer	A2+	A4+	A6+	A8+	A4+M	A4+T	XD4T	XC4	XC6							
Print head																
Printing method	thermal transfer	■	■	■	■	■	■	■	■							
	thermal direct	■	-	■	■	■	■	■	■							
Printable resolution	dpi	300	600	203	300	600	203	300	300							
Print speed	up to mm/s	150	100	250	250	100	200	200	150							
Print width	up to mm	54.2	57	104	105.6	105.6	168	162.6	216							
Material Paper, cardboard, textile, plastics																
Labels or continuous materials on rolls or fanfold		■	■	■	■	■	■	■	□ ¹⁾ □ ¹⁾							
Labels on reel		-	-	-	-	■	■	■	-							
Material thickness mm/weight g/m ²		0.05-0.8/60-300							0.05-0.2/60-180							
Width labels ²⁾	mm	4-63	20-116	46-176	46-220	4-106	4-106	10-110	20-116	46-176						
	liner	mm	24-67	24-120	50-180	50-235	10-110	10-110	10-110	24-120	50-180					
	continuous material	mm	24-67	24-120	50-180	50-235	4-110	4-110	4-110	-	-					
	contin. heat shrink tube	mm	10-67	25-85	-	-	4-85	4-85	4-85	-	-					
Label	without back-feed	from mm	4	4	6	10	5	5	20	20	20					
height ²⁾	when dispensing	from mm	12	12	25	-	-	-	-	-	-					
	up to mm	5,000	2,000	5,000	4,000	1,000	4,000	3,000	2,000	4,000	1,000	4,000	1,000	2,000	2,000	1,500
Media roll	outer diam.	up to mm	205	205	205	205	205	205	300	300	300					
	core diameter	mm	38-100	38-100	38-100	38-100	38-100	38-100	38-100	38-100	76	76				
	winding		Outer or inner													
Ribbon																
Ink side		Outer or inner														
Roll diameter	up to mm	80	80	80	72	80	80	72	72	72						
Core diameter	mm	25	25	25	25	25	25	25	25	25						
Variable length	up to m	500	500	500	360	500	500	360	360	360						
Width ³⁾	up to mm	57	114	165	220	114	114	114	114	165						
Internal rewinder (only with peel-off devices)																
Outer diameter	up to mm	142	142	142	-	-	-	-	-	-						
Core diameter	mm	38.1	38.1	38.1	-	-	-	-	-	-						
Label winding		Outer only	Outer only	Outer only	-	-	-	-	-	-						
Dimensions and weights																
Height	mm	274	274	274	274	274	274	395	395	395						
Depth	mm	446	446	446	446	446	446	554	554	554						
Width	mm	190	242	302	352	242	242	248	248	358						
Weight	kg	8.5	9	13	15	9	9	21	22	24						
Label sensor																
Gap sensor		For leading edge or punch marks and end of material														
Reflective sensor from bottom/opt. top		For print marks														
Distance to locating edge	mm	5-26	5-53	5-53	5-53	-	-	-	5-53	5-53						
	center to the left	mm	-	-	-	0-53	0-53	0-53	-	-						
Electronics																
Processor 32 bit clock rate	MHz	266														
Main storage (RAM)	MB	64														
IFFS printer memory	MB Flash	8														
Plug-in	CompactFlash Type I	■														
	WLAN card	■														
Battery buffer for real-time clock		■														
Acoustic error signal		■														
Interfaces																
Centronics according to IEEE 1284		□							-							
RS232 C		■							-							
USB 2.0 hi-speed slave for PC		■							■							
Ethernet 10/100 Base T, LPD-, RawIP-, FTP-Printing, DHCP, HTTP, SMTP, SNMP, TIME, Zeroconf, mDNS, SOAP		■							■							
RS422/RS485		□							-							
Peripheral connection		■							■							
WLAN 802.11b/g, WEP/WPA-PSK (TKIP)		□							□							
2xUSB hosts for external operation panel, keyboard, scanner, service key, USB stick		■							■							
Operating data																
Power supply		100-240 VAC ~ 50/60 Hz, PFC														
Power consumption	W	100-300 depending on type of printer														
Temperature/humidity operation		5-40 °C/10-85 % not condensing														
storage		0-60 °C/20-80 % not condensing														
transport		-25-60 °C/20-80 % not condensing														
Approvals		CE, FCC class A, CB, CCC, UL														

¹⁾ Continuous materials on rolls only after being tested. ²⁾ Limitations may apply to small labels, thin materials or strong adhesives. These applications need to be tested and approved.

³⁾ Ribbon according to label width in order to avoid folding.

Operation panel	
Buttons/LED displays	Pause, feed, cancel, menu, enter, 4 x cursor
LCD graphic display	Width 60 mm, height 40 mm, 4 lines text, approx. 20 characters per line
Settings	
	Digital or analog clock Time System settings Date Print parameters Interfaces Language settings Security
On display	
	Data reception Clock WLAN field intensity Date sheet Ethernet status abc Debug Used memory Input buffer Temperature print head Remaining ribbon Memory card access
Monitoring	
Stop print job	When end of ribbon When end of labels When print head open When not reached final position of cutter
Testing functions	
System diagnosis	When switched on, including print head testing
Short status, status print	Fonts list, devices list, WLAN status, label profile, test grid, monitor mode, PPP status
Status reports	Printout on device settings, e.g. print length counter, runtime counter, etc. Request of status via software command, status messages on display, e.g. network error - no link, barcode error, etc.
Fonts	
Font types	5 bitmap fonts, incl. OCR-A, OCR-B and 3 vector fonts Swiss 721, Swiss 721 bold and Monospace 821 internally available, TrueType fonts loadable. Optionally: Chinese (simplified), Thai
Character sets	Windows 1250 to 1257, DOS 437, 737, 775, 850, 852, 857, 862, 864, 866, 869, EBC DIC 500, ISO 8859-1 to -10 and -13 to -16, WinOEM 720, UTF-8, Macintosh Roman, DEC MCS, KOI8-R. All Western and Eastern European characters, Latin, Cyrillic, Greek, Hebrew and Arabic are supported. Optionally: Chinese (simplified), Thai
Bitmap fonts	Size of width and height 1-3 mm Zoom factors 2-10 Orientation 0°, 90°, 180°, 270°
Vector/TrueType fonts	Size of width and height 0.9-128 mm Variable zoom, orientation 360° in steps of 1°
Font formats	Bold, italic, underlined, outline, inverse - depending on font types
Font width	Variable

Graphics	
Graphic elements	Lines, arrows, boxes, circles, ellipses, filled and filled with fading
Graphic formats	PCX, IMG, BMP, TIF, MAC, GIF, PNG
Barcodes	
Linear barcodes	Code 39, Code 93 Interleaved 2/5 Code 39 Full ASCII Ident and lead code of Code 128 A, B, C Deutsche Post AG EAN 8, 13 Codabar EAN/UCC 128 JAN 8, 13 EAN/UPC Appendix 2 MSI EAN/UPC Appendix 5 Plessey FIM Postnet HIBC RSS 14 UPC A, E, E0
2D codes	Aztec, Codablock F, Data Matrix, PDF 417, Micro PDF 417, UPS Maxicode, QR code, RSS 14 truncated, limited, stacked and stacked omnidirectional, EAN Datamatrix, GS1 Data Bar All codes are variable in height, module width and ratio. Orientation 0°, 90°, 180°, 270°. Optionally with check digit, printed characters and start/stop code depending on type of code
Software	
Programming	J-Script direct programming ■ abc Basic Compiler ■ Database Connector ■
Monitoring/administration	Printer monitoring ■ Administration Network Manager ■
Label software	cablabel S3 Lite ■ cablabel S3 Viewer ■ cablabel S3 Pro □ cablabel S3 Print □
Windows drivers certified	32/64 bit for ■ Windows Vista Server 2003 Windows 7 Server 2008 Windows 8 Server 2008 R2 Windows 8.1 Server 2012 Windows 10 Server 2012 R2
Mac drivers*	OS X printer drivers starting version 10.6 ■
Linux drivers*	32/64 bit starting CUPS 1.2 ■
Stand-alone operation	■

















*only with A+ series

Accessories - overview

● Typical ○ Possible ■ Standard □ Optionally

			1.1	1.2	1.3	1.4	1.5	1.7	1.8	1.9	1.10
Extra equipment			A2+	A4+	A6+	A8+	A4+M	A4+T	XD4T	XC4	XC6
	Basic device	Peel-off device									
2.1	Metal cover	●	●	□	□	□	□	□	□	□	□
2.2	Print rollers DR4-M25, -M50, -M80	●	-	-	-	-	□	□	□	□	□
2.3	Reflective label sensor - from top	●	●	□	□	□	□	-	-	-	-
2.4	Adapter 100 mm diameter	●	●	□	□	□	□	□	□	□	□
2.5	Memory card	●	●	□	□	□	□	□	□	□	□
2.6	Standard USB keyboard	●	●	□	□	□	□	□	□	□	□
2.7	External operation panel	●	●	□	□	□	□	□	□	□	□
2.8	Pause adapter PS7 - print job interruption	●	○	□	□	□	□	-	-	-	-
2.9	Tester CC for linear and 2D barcodes	●	●	□	□	□	-	-	-	-	-
Interfaces											
3.1	Centronics according to IEEE 1284	●	●	□	□	□	□	□	-	-	-
3.2	RS422/RS485	●	●	□	□	□	□	□	-	-	-
3.3	Label selection – I/O box	●	●	□	□	□	□	□	□	□	□
3.4	WLAN 802.11b/g	●	●	□	□	□	□	□	□	□	□
Connecting cables											
4.1	Connecting cable RS232 C, 9/9-pin, length 3 m	●	●	□	□	□	□	□	□	□	□
4.2	Patch cable CAT 5e, length 3 m, gray	●	●	□	□	□	□	□	□	□	□
Cutting labels, perforating labels, stacking labels											
5.1	Cutter CU	●	○	□	□	□	□	□	□	□	□
5.2	Cutter tray	●	○	-	□	-	-	□	-	-	-
5.3	Perforation cutter PCU4	●	○	-	□	-	-	□	□	○	-
5.4	Stacker with cutter ST4/L	●	○	-	□	-	-	-	-	□	-
	Stacker with cutter ST4/M	●	-	-	-	-	-	□	□	□	-
5.5	Base frame A4+	●	-	-	□	-	-	□	□	-	-
Rewinding labels, unwinding labels											
6.1	Rewind guide plate for internal rewinding	-	●	□	□	-	-	-	-	-	-
6.2	External rewinder for direct printer connection	●	○	□	□	□	□	-	-	-	-
6.3	External rewinder with built-in power supply	●	○	□	□	□	□	□	□	□	□
6.4	External unwinder for rolls up to 300 mm diameter	●	○	□	□	□	□	□	□	□	□
6.5	Adapter kit A2+, A4+, A6+, A8+	●	○	□	□	□	-	-	-	-	-
6.6	Adapter kit XC4, XC6	●	-	-	-	-	-	-	-	□	□
Dispensing labels											
7.1	Peel-off adapter PS5 for automatic operation	-	●	□	□	□	-	-	-	-	-
7.2	Extended peel-off plate	-	●	□	□	□	-	-	-	-	-
7.3	Present sensor PS6 for manual or automatic operation	-	●	□	□	□	-	-	-	-	-
7.4	Present sensor PS8 for manual operation	-	●	□	□	□	-	-	-	-	-
7.5	Present sensor PS9 variable	-	●	□	□	-	-	-	-	-	-
For dispensing labels											
8.1	Hand switch TR1	-	●	□	□	□	-	-	-	-	-
8.2	Foot switch	-	●	□	□	□	-	-	-	-	-
8.3	Interface connector/15-pin Sub-D plug	-	●	□	□	□	-	-	-	-	-
8.4	Product sensor	-	●	□	□	□	-	-	-	-	-
8.5	Testbox 2 - automatic operation	-	●	□	□	□	-	-	-	-	-
Applicators and dispensing module											
9.1	Dispensing module A5100	-	●	-	□	□	-	-	-	-	-
9.2	All-around labeler	-	●	□	□	-	-	-	-	-	-
9.3	Applicator A1000	-	●	□	□	□	-	-	-	-	-
	Tamp pad A1021 WxH	-	●	□	□	□	-	-	-	-	-
9.4	Universal tamp pad A1021 70x60	-	●	□	□	○	-	-	-	-	-
	Universal tamp pad A1021 90x90	-	●	-	□	○	-	-	-	-	-
	Tamp pad A1321 WxH	-	●	-	□	□	-	-	-	-	-
9.5	Universal tamp pad A1321 116x102	-	●	-	□	○	-	-	-	-	-
	Universal tamp pad A1321 116x152	-	●	-	□	○	-	-	-	-	-
9.6	Blow pad A2021 WxH	-	●	□	□	□	-	-	-	-	-
9.7	Roll-on pad A1411 WxH	-	●	-	□	□	-	-	-	-	-
9.8	Applicator A3200	-	●	□	□	-	-	-	-	-	-
9.9	Tamp pad A3221 WxH	-	●	□	□	-	-	-	-	-	-
9.10	Blow pad A3221 WxH	-	●	□	□	-	-	-	-	-	-
Label dispensers and applicators											
10.1	Mounting plate	-	●	□	□	-	-	-	-	-	-
10.2	Profile 40/80/120 mm	-	●	□	□	-	-	-	-	-	-
10.3	Base plate 500x255 mm	-	●	□	□	-	-	-	-	-	-
10.4	Floor stand 1600	-	●	□	□	□	-	-	-	-	-
10.5	Printer holder A2+, A4+, A6+	-	●	□	□	□	-	-	-	-	-
Software											
11.4	Database Connector	●	●	■	■	■	■	■	■	■	■
11.6	Administration Network Manager	●	●	■	■	■	■	■	■	■	■
	Label software cablabel S3 Lite	●	●	■	■	■	■	■	■	■	■
11.7	Label software cablabel S3 Pro	●	●	□	□	□	□	□	□	□	□
	Label software cablabel S3 Print	●	●	□	□	□	□	□	□	□	□
11.10	Programming manual	●	●	□	□	□	□	□	□	□	□

Accessories - special equipment, interfaces, connecting cables

Extra equipment		
2.1		<p>Metal cover On request, label printers A4+ and A6+ are available with metal cover (standard with the A8+).</p>
2.2		<p>Print roller DR4-M25 For small and thin materials up to 25 mm width</p>
		<p>Print roller DR4-M50 For very thin materials from 20 to 50 mm width</p>
		<p>Print roller DR4-M80 For very thin materials up to 80 mm width</p>
2.3		<p>Reflective label sensor From top</p>
2.4		<p>Adapter 100 mm diameter To keep bending to a minimum during stacking it is recommended to use a large core diameter.</p>
2.5		<p>Memory card CompactFlash Type I</p>
2.6		<p>Standard keyboard Connection USB, number of keys 115</p>
2.7		<p>External operation panel If the operation panel is not accessible, after printer installation within a facility, an external one can be connected. Additional slots are available for CompactFlash memory card Type I and host interface.</p>
2.8		<p>Pause adapter PS7 For printing in a label loop. Print job is stopped by the pause signal, with the label being printed finished first.</p> <p>I/O interface Inputs: Outputs: No print job, Pause, external error printer not ready, print job active</p>
2.9		<p>Tester CC for linear and 2D barcodes A camera testing horizontally and vertically printed barcodes directly after printing. If the code is faulty the print job is stopped and the label removed. The tester CC can be used with tear-off mode, dispensing mode or external rewriter. For further details please refer to the operation manual.</p>
Interfaces		
3.1		<p>Centronics Interface Bi-directional according to IEEE 1284</p>
3.2		<p>RS422/RS485 1,200 to 230,400 baud/8 bit</p>
3.3		<p>Label selection - I/O box From a higher-level control, like a PLC, up to 16 different labels can be selected from the memory card. The I/O box via abc programming enables to realize easy PLC programming with four in- and outputs each.</p>
3.4		<p>WLAN 802.11b/g</p>
Connecting cables		
4.1		<p>Connecting cable RS232 C, 9/9-pin, length 3 m</p>
4.2		<p>Patch cable CAT 5e, length 3 m, gray</p>

Accessories - cutting labels, perforating labels, stacking labels

5.1



Cutter CU

Used to cut paper labels, self-adhesive labels, cardboard, textile or synthetic materials as well as heat shrink tubes.

Cutter tray

Up to about 50 labels may be collected in the cutter tray.

Cutter	CU2	CU4	CU6	CU8	
Usage	A2+	A4+	A4+M, A4+T XD4T, XC4	A6+ XC6	A8+
Material width up to mm	67	120	110	180	232
Material weight cardboard gr/m ²	60-500				
Material thickness mm	0.05-0.8				
Cutting length mm	>5				
Gap height up to mm	2.5				
Cuts/min.	130	120	110	100	
Stop print job	When final position of cutter is not reached				
Cutter tray 4 for A4+, A4+M					
Label height up to mm	100				

5.2

5.3



Perforation cutter PCU4

Enables the perforation of the material for later manual separation.

Perforation cutter	PCU4
Usage	A4+, A4+M, A4+T, XD4T, XC4
Material width up to mm	85
Material weight cardboard gr/m ²	60-300
Material thickness mm	0.05-0.8
Cutting length mm	>5
Gap height up to mm	4.5
Cuts/min.	Cutting 120/perforating 150
Stop print job	When final position of cutter is not reached
Perforating: Web width mm	0.5
Web distances mm	2.5 or 10

5.4



Stacker with cutter ST4

Printed materials are cut and stacked. The print job is stopped as soon as the maximum stack height is reached. Even stiff or curved materials may be processed to some extent. We recommend to have your material tested at our facilities.

Stacker with cutter	ST4/L	ST4/M
Usage	A4+, XC4	A4+M, A4+T, XD4T
Material width up to mm	20-110	20-100
Material weight cardboard gr/m ²	60-300	
Material thickness mm	0.05-0.8	
Cutting length mm	20-150	
Gap height up to mm	1.2	
Cuts/min.	120	
Stop print job	When final position of cutter is not reached, when cover open, when stack height reached	
Stack height up to mm	100	

5.5



Storage table label WxH

Storage table and protective cover are adapted to the label size and need to be ordered separately.



Base frame A4+

Used to place the devices on the table in any position.

Accessories - rewinding labels, unwinding labels



Rewind guide plate RG for internal rewinding

Internal rewinding is done by dispensing printers. In this case, the peel-off plate is replaced by the rewind guide plate.

Rewind guide plate	RG2	RG4
Usage	A2+ dispensing version	A4+ dispensing version
Material width up to mm	67	120
Roll diameter up to mm	140	140
Core diameter mm	40	40
Label winding	Outer	



External rewinders ER1/2/3 for direct printer connection

The rewriter is directly screwed onto the printer. Labels are optionally wound either inner or outer side. Electronic control by the swing arm ensures a smooth and tight winding.

External rewriter	ER1/210	ER2/210	ER3/210
Usage	A2+	A4+	A6+ A8+
Material width up to mm	67	120	180 235
Roll diameter up to mm	205	205	205 205
Core diameter mm	40/76		
Label winding	Outer or inner		

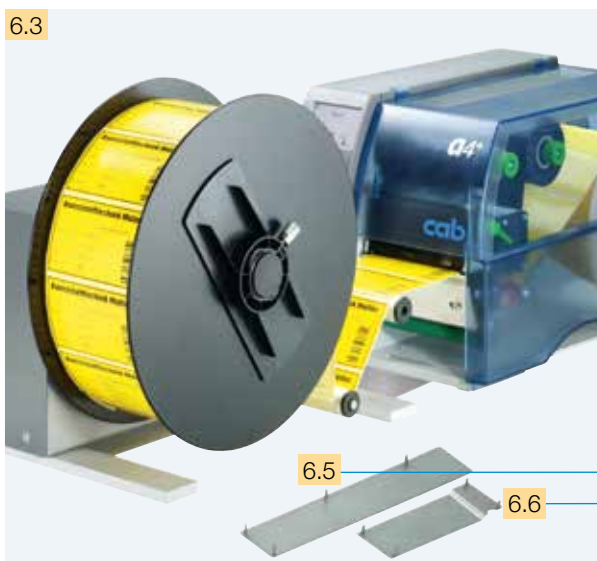

External rewinders ER4/6/8 with built-in power supply

The rewriter may be attached to any external printer. All other technical data according to rewinders ER1/2/3.

External rewriter	ER4/210	ER4/300	ER6/300	ER8/300
Usage	A2+ A4+, A4+M, A4+T, XD4T XC4	A2+ A4+, A4+M, A4+T, XD4T XC4	A6+ XC6	A8+
Material width up to mm	67 120	67 120	180	235
Roll diameter up to mm	205 205	300 300	300	300
Core diameter mm	40 / 76			
Label winding	Outer or inner			
Operating voltage	100-240 V ~ 50/60 Hz			

For exact alignment of the external rewriter to the printer an adapter kit is offered.

Adapter kit	For A2+, A4+, A6+, A8+
Adapter kit	For XC4, XC6



External unwinders EU4/6/8

Ensure a smooth label feed with heavy rolls. Both inner and outer site wound rolls may be used.

External unwinder	EU4/300	EU6/300	EU8/300
Usage	A2+ A4+, A4+M, A4+T	A6+	A8+
Material width up to mm	67 120	180	235
Roll diameter up to mm	300 300	300	300
Core diameter mm	40/76		
Label winding	Outer or inner		





For exact alignment of the external unwinder to the printer an adapter kit is offered.

Adapter kit	For A2+, A4+, A6+, A8+
--------------------	-------------------------------

Accessories - dispensing labels







- 1 Dispensing printers ("P" types) additionally need to have a peel-off adapter or present sensor. Different types for either manual operation, or via hand switch, foot switch or an external signal are available.

Dispensing labels											
<p>7.1</p> 	<p>Peel-off adapter PS5 for automatic operation Printing and dispensing the label is triggered via external signal. The label is removed by an applicator or robot.</p> <p>I/O interface</p> <table border="0"> <tr> <td>Inputs:</td> <td>Outputs:</td> </tr> <tr> <td>Start</td> <td>No print job</td> </tr> <tr> <td>Label removed</td> <td>Printer not ready</td> </tr> <tr> <td>External error</td> <td>Print job active</td> </tr> <tr> <td></td> <td>Label in dispensing position</td> </tr> </table>	Inputs:	Outputs:	Start	No print job	Label removed	Printer not ready	External error	Print job active		Label in dispensing position
Inputs:	Outputs:										
Start	No print job										
Label removed	Printer not ready										
External error	Print job active										
	Label in dispensing position										
<p>7.2</p> 	<p>Extended peel-off plate For labels particularly difficult to remove from liner the peel-off plate with rewind guide plate, extended by 10 mm, is used. Only in connection with present adapter PS5 or an applicator.</p>										
<p>7.3</p> 	<p>Present sensor PS6</p> <p>1. Manual operation The present sensor detects the label being in dispensing position and interrupts the print job. As soon as the label has been manually removed the next one is printed immediately.</p> <p>2. Automatic operation Dispensing via hand switch, foot switch, or an external signal</p> <p>I/O interface</p> <table border="0"> <tr> <td>Inputs:</td> <td>Outputs:</td> </tr> <tr> <td>Start</td> <td>No print job</td> </tr> <tr> <td>External error</td> <td>Printer not ready</td> </tr> <tr> <td></td> <td>Print job active</td> </tr> <tr> <td></td> <td>Label in dispensing position</td> </tr> </table>	Inputs:	Outputs:	Start	No print job	External error	Printer not ready		Print job active		Label in dispensing position
Inputs:	Outputs:										
Start	No print job										
External error	Printer not ready										
	Print job active										
	Label in dispensing position										
<p>7.4</p> 	<p>Present sensor PS8 for manual operation The present sensor detects the label being in dispensing position and interrupts the print job. As soon as the label has been manually removed the next one is printed immediately.</p>										
<p>7.5</p> 	<p>Present sensor PS9 variable For dispensing e.g. round labels where the leading edge of the label cannot be detected by the PS8. Extension is customized.</p>										

Accessories - for dispensing labels

For peel-off adapter PS5,
present sensor PS6,
pause adapter PS7,

dispensing modules A5104/A5106,
applicator A1000,
applicator A3200

For dispensing labels	
8.1	 <p>Hand switch TR1 Printing and dispensing on demand</p>
8.2	 <p>Foot switch Printing and dispensing on demand</p>
8.3	 <p>Interface connector/Sub-D plug Sub-D plug 15-pin with screw clamps for PS5, PS6, PS7 and applicators. To connect external control signals.</p>
8.4	 <p>Product sensor For automatic product detection on the conveyor belt</p>
8.5	 <p>Testbox 2 Simulation of automatic operation</p>



Dispensing module with peel-off adapter PS5

For labeling packages on a conveyor belt. The product sensor triggers the printing process. Labeling is started and at the same time the next label is printed. Conveyor speed and print speed need to be synchronized.

	A5104	A5106
Usage	A4+	A6+
Label width mm	25-116	50-176
Label height mm	25-200	
Product surface	Flat	
Product height	Fixed	
Product during labeling	In motion with speed synchronized to printer	



All-around labeler

Combined with the A1000 applicator labels on cylindrical objects around the entire circumference of 360° can be applied. The product is put on the rolls and labeling is started via hand or foot switch.

All-around labeler	
Usage	A2+, A4+ with applicator A1000-220
Product diameter mm	12-40
Product surface	Cylindrical
Product during labeling	In rotary motion
Tamp pad A1021 WxH	
Label width mm	25-116
Label height mm	25-140

Applicator A1000

9.3

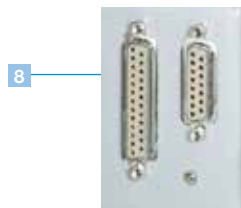

Real-time application

Combined with the A2+, A4+ and A6+ printers the A1000 applicator means a cost-effective solution - for both semi-automatic operation and integration into product lines. For operation compressed air of 4,5 bar is needed.

1 Long service life

The ball-bearing guide bars are low-wearing.

2 Variable product heights

The lifting cylinder allows labeling at different heights. Different stroke heights are available.

3 Pre-dispensing button

For testing the labeling process. Pushing the button the first time causes the label to be printed and held by the pad. Pushing the button again starts the application.

4 Compressed air regulation unit

Microfilters prevent contamination. The compressed air regulator ensures a permanent high labeling quality.

5 High process reliability

The supporting air jet stream, induction air and lifting speed can be adjusted. The pressure can be reduced to less than 10 N (1 kg) for highly sensitive products and packages. To avoid contamination of the vacuum holes, these are cleaned with air pressure after each application.

6 Label sizes

Labels with 25 to 176 mm width and 25 to 200 mm height can be applied.

7 Supporting air

Used for blowing the label onto the pad

8 Digital I/O interface

A PLC, sensor or hand switch starts the labeling. At the same time, status and error messages are issued.

Inputs:

- Start
- Print first label
- External error
- Stop (external error)
- External reset only for 25-pin

Outputs:

- Printer not ready
- No print job
- Collective alarm
- Home position reached
- Labeling position reached
- Labeling error

Applicator	A1000-220	A1000-300	A1000-400
Usage	A2+, A4+, A6+	A2+, A4+, A6+	A2+, A4+, A6+
Cylinder stroke	mm 220	300	400
Tamp stroke below device	mm 70	150	250
Compressed air	bar 4.5		

Accessories - Applicator A1000

9.4



Tamps

Labels are applied on the tamp and held by vacuum. Tamp and label are then moved to the product by applicator.

Universal tamp pad

The rasterized vacuum holes are covered by a foil and are pierced according to the label size.

Tamp pads are manufactured according to the label size.

	Universal tamp pads			Tamp pad		
	A1021 70x60	A4+	A1021 90x90	A4+	A1021 WxH	
Usage	A2+	A4+	A4+	A2+	A4+	A6+
Label width mm	25-63	25-70	25-90	25-63	25-116	50-176
Label height mm	25-60		25-90	25-200		
Product surface	Flat					
Product height	Variable					
Product during labeling	Not moving					

9.5



Tamp spring-mounted

The spring deflection allows labeling even on inclined surfaces.

Universal tamp pad

The rasterized vacuum holes are covered by a foil and are pierced according to the label size.

Tamp pads are manufactured according to the label size.

	Universal tamp pads		Tamp pad			
	A1321 116x102	A4+	A1321 116x152	A4+	A1321 WxH	A6+
Usage	A4+		A4+		A4+	A6+
Label width mm	25-116		25-116		25-116	50-176
Label height mm	25-102		25-152		25-200	
Product surface	Flat					
Product height	Variable					
Product during labeling	Not moving					

9.6

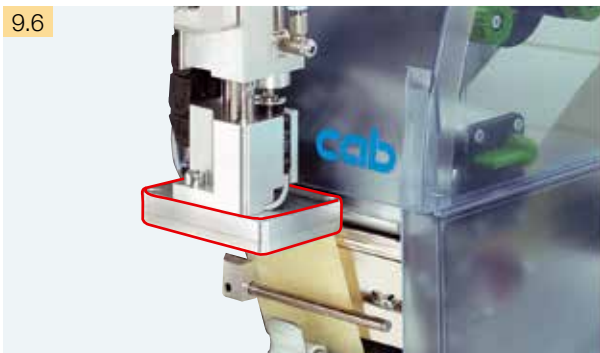

Blow pad

In case of pressure-sensitive products, the label can be blown on. Thus, the blow pad moves to a fixed height. The product to be printed is positioned about 10 mm below.

Blow pad	A2021		
Usage	A2+	A4+	A6+
Label width mm	25-63	25-116	50-176
Label height mm	25-100		
Product surface	Flat		
Product height	Fixed		
Product during labeling	Not moving or in motion		

9.7

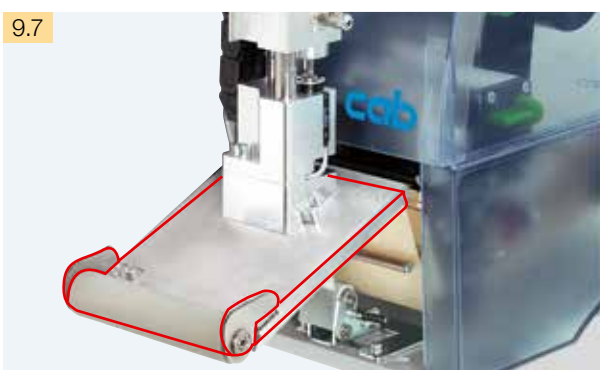

Roll-on pad

Using the roll-on pad the label is moved to below the roll. The pad moves onto the product and the label is rolled on during transport.

Roll-on pad	A1411	
Usage	A4+	A6+
Label width mm	25-116	50-76
Label height mm	80-200	80-200
Product surface	Flat	
Product height	Variable	
Product during labeling	In motion	

Applicator A3200

9.8



Real-time application

With the A3200 applicator labels that are printed with the A2+ or A4+ printers are automatically applied on a product. A rotary cylinder allows positioning the label between 45° and 95°. Finally, the label is placed on the product via short stroke cylinder.

1 Long service life

The ball-bearing guides are low-wearing.

2 Variable angular position

The rotary cylinder allows labeling on horizontal, inclined and vertical surfaces.

3 Pre-dispensing button

For testing the labelling process. Pushing the button the first time causes the label to be printed and held by the pad. Pushing the button again starts the application.

4 Compressed air regulation unit

Microfilters prevent contamination. The compressed air regulator ensures a permanent high labeling quality.

5 High process reliability

The supporting air jet stream, induction air and lifting speed can be adjusted. The pressure can be reduced to less than 10 N (1 kg) for highly sensitive products and packaging. To avoid contamination of the vacuum holes, these are cleaned with air pressure after each application.

6 Label sizes

Labels with 4 to 116 mm width and 5 to 80 mm height can be applied.

7 Supporting air

Used for blowing the label onto the pad

8 Digital I/O interface

A PLC, sensor or hand switch starts the labeling. At the same time, status and error messages are issued.

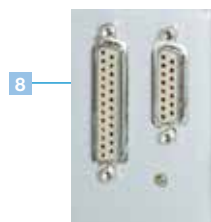

Inputs:

- Start
- Print first label
- External error
- Stop (external error)
- External reset only for 25-pin

Outputs:

- Printer not ready
- No print job
- Collective alarm
- Home position reached
- Labeling position reached
- Labeling error

Applicator	A3200
Usage	A2+, A4+
Rotary cylinder	45°-95°
Lifting cylinder up to mm	30
Compressed air bar	4.5

Tamp pads or blow pads are manufactured according to the label size.

	Tamp pad A3221		Blow pad A3221	
	A2+	A4+	A2+	A4+
Usage	A2+	A4+	A2+	A4+
Label width mm	4-63	20-116	10-63	20-16
Label height mm	5-80		10-80	
Product surface	Flat			
Product during labeling	Not moving		In motion	

9.9



9.10

Accessories - mounting equipment



Mounting foot (for A2+, A4+)

For fastening the print and apply system and product holder.

1 Mounting plate

The print and apply system is fastened on the mounting plate.

2 Profile

Standard lengths 40, 80, 120 mm. The aluminum square profile can also be manufactured in other lengths upon request.

3 Base plate

For fastening the product holder
Standard size 500x255 mm



Floor stand

Enables the printer to be quickly and flexibly integrated into any manufacturing line. Height and width of the labeling position are easy to adjust. Four guide rollers at the chassis provide for mobility. The floor stand is adjusted with adjustable feet at the place of operation.

Floor stand		1600
Total height	mm	1600
Labeling height	up to mm	1400
Projection until middle of label	mm	230-500
Chassis WxDxH	mm	600x860x140



Printer holder

The A2+, A4+ or A6+ label printers are fixed on the plate and quicklocked.

Label software cablabel S3



cablabel S3 concentrates label design, print control and monitoring of all cab marking systems. The development of devices and software is synchronized.

Highlights

Like no other software available cablabel S3 develops the full potential of cab devices. The software utilizes the JScript code to the full extent. The Pro product imports existing JScript files, so you can switch over easily to new software. With the new layer technology the user designs a label which works for all established devices and resolutions. Intelligent print control evaluates both device and resolution for printout and provides the proper data. Thus, possible sources of error are reduced.

cablabel S3 also maximizes the integration of database connections via Database Connector. After designing the label, the software provides all files to be stored within the printer for database connections. Stand-alone operation independent from a host system is supported. In addition the software creates interfaces which are easy to handle for SAP connection or other devices like PLC, scales and barcode testers.

Functional range

Every company designs and formats their label printing differently. For example, label creation and production are executed by different employees. To adopt the software package to specific needs, cab offers different software packages.

- *cablabel S3 Lite* is offered free of costs with every cab printer and allows to create and print labels.
- With cost-saving *cablabel S3 Pro* label designs for professional technical solutions can be created.
- *cablabel S3 Viewer* shows the preview of a label in the Windows Explorer and - like the Lite product - is delivered free of costs with every cab printer. The Viewer may support showing examples during the approval processes or supplier requirements.
- *cablabel S3 Print* is provided for users in production or warehouse. The user interface is simplified and provides only those functions which are required for label printing.

Other products like cablabel S3 Pro Laser, Print Laser and Print Server are in preparation.

Integration



No printer works isolated. In a productive environment it is connected to other equipment or networks for control and monitoring. cab offers various possibilities to integrate the printer into your business environment.

Control

Every cab printer can be directly coded with the simple programming language *JScript* and an extensive instruction set. Direct programming is supported by cablabel S3, but may also be created with any text editor.

As an integrated element of the firmware, the *abc Basic Compiler* enables the printer to process data via BASIC programming before it is sent for print editing. That way, you replace external printer languages or integrate data from other systems, e.g. scale or PLC.

11.4 The *Database Connector* enables printers to access data directly from a central ODBC- or OLEDB compatible database and to print it as a label.

In cooperation with SAP* cab developed the so-called *replace method* to control cab printers quickly and easily from SAPScript using SAP R/3. Using this method the host computer only sends the JScript variable, respectively changed data to the printer. As a Silver Level Partner in SAP's printer vendor program, cab has access to SAP development environments for optimum printer support.

* SAP and all SAP logos are trademarks or registered trademarks of SAP SE in Germany and in several other countries.

11.10 The *Programming manual* explains and describes commands for different printer models via direct programming with JScript and abc and the connection of the printer to databases via Database Connector.

For printer control via PC drivers are available for Windows operating systems. For A+ printers in addition CUPS-based drivers for Mac OS X and Linux. The drivers ensure optimum stability on your operating system.

Monitoring

Using standard programs such as the web browser or FTP clients, the integrated HTTP and FTP servers enable printer monitoring and configuration, firmware updates and memory card administration. Status, warning and error messages are sent to administrators or users via e-mails or SNMP datagrams via SNMP and SMTP clients. A time server is used to synchronize time and date.

11.6 The *Administration Network Manager* enables the user to control a number of printers across a network simultaneously. It supports monitoring, configuration, firmware updates, memory card administration, file synchronization and PIN administration centrally.

Stand-alone operation



Printing without PC

Stand-alone operation is the ability of cab printers to print labels even if these devices are not connected to the host system.

The layout is designed with a special label software or direct programming via PC.

Label formats, fonts, text and graphics data as well as database contents are saved or read on the CompactFlash memory card, USB stick or internal IFFS printer memory.

Only variable data to be printed is sent to the printer via keyboard or host. Additionally, data sent by a barcode scanner or scale can be processed.

Easy maintenance



Label sensor

For cleaning the label sensor is unlocked and pulled out with slight finger pressure.



Print head

The print head may be exchanged in just few steps. No need of adjustments and settings.



Print roller

Three screws allow an easy and fast removing of the print roller for cleaning or replacement.



Assembling tool

For replacing wear parts or mounting peripherals ONE single tool is inserted in the printer ready to hand.

Service



Well-trained cab service engineers give worldwide support in maintenance and repair. Please send your printer to one of cab's service centres or one of our selected service partners. We will check and repair your printer within a few days. If requested, we will make a temporary equivalent device available for the time of repair.

Training



We offer information on the programming of different software tools, printer drivers and label layout design. Enhance your knowledge on cab printers to make more effective use of cab printers. We also offer seminars for maintenance and repair.

Label printers - product range

























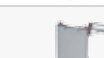

		Part no.	Printers	dpi	Part no.	Print heads	dpi	Part no.	Wear parts
1.1		5954511	Label printer A2+	300	5954105.001	Print head 2	300	5954102.001 5954104.001	Print roller DR2 Rewind assist roller RR2
		5954512	Label printer A2+	300P					
		5954575	Label printer A2+	600	5958686.001	Print head 2	600		
		5954578	Label printer A2+	600P					
1.2		5954500	Label printer A4+	200	5954081.001	Print head 4	203	5954180.001 5954183.001	Print roller DR4 Rewind assist roller RR4
		5954505	Label printer A4+	200P					
		5954501	Label printer A4+	300	5954072.001	Print head 4	300		
		5954506	Label printer A4+	300P					
	5954502	Label printer A4+	600	5954077.001	Print head 4	600			
	5954507	Label printer A4+	600P						
	5954524	Label printer A4.3+	200	5954085.001	Print head 4.3	203			
	5954526	Label printer A4.3+	200P						
5954525	Label printer A4.3+	300	5954089.001	Print head 4.3	300				
5954527	Label printer A4.3+	300P							
1.3		5954587	Label printer A6+	200	5954217.001	Print head 6	203	5954245.001 5954246.001	Print roller DR6 Rewind assist roller RR6
		5954588	Label printer A6+	200P					
		5954513	Label printer A6+	300	5954106.001	Print head 6	300		
5954514	Label printer A6+	300P							
1.4		5954517.101	Label printer A8+ with metal cover	300	5954107.001	Print head 8	300	5954103.001	Print roller DR8
1.5		5954552	Label printer A4+M	300	5954072.001	Print head 4	300	5954180.001 5954183.001	Print roller DR4 Rewind assist roller RR4
		5954554	Label printer A4+M	600					
1.7		5954568	Label printer A4+T	300	5954072.001	Print head 4	300	5954180.001	Print roller DR4
		5954570	Label printer A4+T	600					
1.8		5959970	Label printer XD4T	300	5954072.001	Print head 4	300	5954180.001	Print roller DR4
1.9		5965700	Label printer XC4	300	5954072.001	Print head 4	300	5954180.001	Print roller DR4
1.10		5965701	Label printer XC6	300	5954106.001	Print head 6	300	5954245.001	Print roller DR6
		Part no.	Special printers						
1.11		59545xx.101*	Printer with metal cover for A4+, A4+M, A4+T or A6+	Scope of delivery: Label printer, power cable E+F type, length 1,8 m, connecting cable USB, length 1,8 m, operation manual de/en DVD: Operation manual in more than 20 languages (only with A+ series), operation manual de/en/fr/es/it (with X series) configuration manual de/en/fr, service manual de/en, spare parts list de/en, programming manual en, printer drivers 32/64 bit in more than 20 languages for Windows Vista Server 2003 Windows 7 Server 2008 Windows 8 Server 2008 R2 Windows 8.1 Server 2012 Windows 10 Server 2012 R2 Mac OS X drivers de/en/fr (only with A+ series), Linux drivers de/en/fr (only with A+ series), Label software cablabel S3 Lite, cablabel S3 Viewer Database Connector					
1.12		595xxxx*	Label printer for thermal direct printing on request						

* Instead of "x" please choose the article no. of the cab printer as listed above.

Accessories - product range

	Part no.	Special equipment
2.1	 5954012.001	Metal cover for A4+
	 5954013.001	Metal cover for A6+
2.2	 5953700.001	Print roller DR4-M25
	 5953701.001	Print roller DR4-M50
	 5953702.001	Print roller DR4-M80
2.3	 5958631	Reflective label sensor from top
2.4	 5959622.001	Adapter 100
2.5	 5561043	Memory card CompactFlash Type I
2.6	 5901626	Standard USB keyboard German version
2.7	 5954380	External operation panel
2.8	 5946146	Pause adapter PS7
2.9	 5571005	Barcode tester CC2
	 5571000	Barcode tester CC4
	Part no.	Interfaces
3.1	 5954200	Centronics according to IEEE 1284
3.2	 5954201	RS422/RS485
3.3	 5954191	Label selection – I/O box
3.4	 5561041	WLAN 802.11b/g
	Part no.	Connecting cables
4.1	 5550818	Connecting cable RS232 C 9/9-pin, length 3 m
4.2	 5918008	Patch cable CAT 5e, length 3 m, gray
	Part no.	Cutting, perforating, stacking
5.1	 5948382	Cutter CU2
	 5948000	Cutter CU4
	 5948001	Cutter CU6
	 5948002	Cutter CU8
5.2	 5946995	Cutter tray 4
5.3	 5960050.351	Perforation cutter PCU4/2,5
	 5960050.352	Perforation cutter PCU4/10
5.4	 5541311	Stacker with cutter ST4/L
	 5541313	Stacker with cutter ST4/M
5.4	 55xxxxx**	Storage table ST4/L, label WxH
	 55xxxxx**	Storage table ST4/M, label WxH
5.5	 5958932	Base frame A4+







** User specific article no. following request

	Part no.	Rewinding labels, unwinding labels
6.1	 5954108.001	Rewind guide plate RG2 for internal rewinding
	 5954190.001	Rewind guide plate RG4 for internal rewinding
6.2	 5948102	External rewinder ER1/210
	 5943251	External rewinder ER2/210
	 5945802	External rewinder ER3/210
6.3	 5948100	External rewinder ER4/210
	 5946090	External rewinder ER4/300
	 5946420	External rewinder ER6/300
	 5945804	External rewinder ER8/300
6.4	 5946091	External unwinder EU4/300
	 5946421	External unwinder EU6/300
	 5945806	External unwinder EU8/300
6.5	 5948170	Adapter kit for A2+, A4+, A6+, A8+
6.6	 5965712	Adapter kit for XC4
	 5965713	Adapter kit for XC6
	Part no.	Dispensing labels
7.1	 5946120	Peel-off adapter PS5 Automatic operation
7.2	 5958772	Extended peel-off plate A2+
	 5948830	Extended peel-off plate A4+
	 5958565	Extended peel-off plate A6+
7.3	 5942353	Present sensor PS6 Manual/automatic operation
7.4	 5946900	Present sensor PS8 Manual operation
7.5	 5948595	Present sensor PS9 Variable
	Part no.	Accessories for dispensing labels
8.1	 5942345	Hand switch TR1
8.2	 5535901	Foot switch
8.3	 5917652	Interface connector 15-pin SUB-D plug Phoenix Contact 2761606
8.4	 5941526	Product sensor
8.5	 5533240	Testbox 2 Automatic operation

Accessories - product range

		Part no.	Applicators and dispensing modules
9.1		5949281 5949265	Dispensing module A5104 Dispensing module A5106
9.2		5941345	All-around labeler
9.3		5949001 5949002 5949003	Applicator A1000-220 Applicator A1000-300 Applicator A1000-400
9.4		5xxxxxx**	Tamp pad A1021 WxH
		5949072	Universal tamp pad A1021 70x60
		5949075	Universal tamp pad A1021 90x90
9.5		5xxxxxx**	Tamp pad A1321 WxH
		5949076	Universal tamp pad A1321 116x102
		5949077	Universal tamp pad A1321 116x152
9.6		5xxxxxx**	Blow pad A2021 WxH
9.7		5xxxxxx**	Roll-on pad A1411 WxH
9.8		5976050	Applicator A3200
9.9		5xxxxxx**	Tamp pad A3221 WxH
9.10		5xxxxxx**	Blow pad A3221 WxH

** User specific article no. following request

		Part no.	Mounting equipment
10.1		5969811 5958367	Mounting plate for A2+ Mounting plate for A4+
10.2		5958365 5965929 5971136	Profile 40 Profile 80 Profile 120
		5xxxxxx**	Profile L
10.3		5961203	Base plate 500x255
10.4		5947400	Floor stand 1600
10.5		8914422	Printer holder for A2+
		8913693	Printer holder for A4+
		8914423	Printer holder for A6+
		Part no.	Label software
11.7		5588000	cablabel S3 Lite
		5588001	cablabel S3 Pro 1 WS
		5588100	cablabel S3 Pro 5 WS
		5588101	cablabel S3 Pro 10 WS
		5588150	cablabel S3 Pro 1 additional licence
		5588151	cablabel S3 Pro 4 additional licences
		5588152	cablabel S3 Pro 9 additional licences
		5588002	cablabel S3 Print 1 WS
		5588105	cablabel S3 Print 5 WS
		5588106	cablabel S3 Print 10 WS
		5588155	cablabel S3 Print 1 additional licence
		5588156	cablabel S3 Print 4 additional licences
		5588157	cablabel S3 Print 9 additional licences
		In preparation	cablabel S3 Print Server
11.10		9008486	Programming manual en, printed copy

cab product range at a glance

Label printer EOS1
The compact one for label rolls up to 155 mm diameter



Label printer EOS4
The cost-effective one for label rolls up to 210 mm diameter



Label printer EOS mobile
Both EOS sizes with battery pack for mobile print



Label printers A+ series
The universal ones



Label printer A4+M
With centered material positioning



Label printer A4+T
With centered material positioning also for textile materials



Label printer XD4T
Double-sided printing



Label printers XC series
Two-color printing



Label dispensers HS/VS
Precise horizontal or vertical dispensing up to 180 mm width



Print & apply system Hermes+
For automation



Print & apply system Hermes C
For two-color printing and applying



Print modules PX series
For integration into automatic labeling systems



Consumables
Precise printing with cab labels and ribbons



Label software cablabel S3
Standard and optional



Laser marking system FL+ series
Precise and fast



Laser safety housing
The industrial solution



 Headquarter and fabrication in Germany

 to  International subsidiaries

There are furthermore 820 distribution partners in more than 80 countries.



Europe

Germany

cab Produkttechnik GmbH & Co KG
Wilhelm-Schickard-Str. 14
76131 Karlsruhe
phone +49 721 6626 0
fax +49 721 6626 129
info@cab.de
www.cab.de

cab Produkttechnik Sömmerda GmbH
Am Unterwege 18-20
99610 Sömmerda
phone +49 3634 6860 0
fax +49 3634 6860 129
info@cab.de
www.cab.de

France

cab Technologies S.à.r.l.
2a Rue de la Moder
Z.A. Nord du Val de Moder
67350 Niedermodern
phone +33 388 722501
fax +33 388 722502
info.fr@cab.de
www.cab.de/fr

America

USA

cab Technology, Inc.
87 Progress Avenue Unit 1
Tyngsboro, MA 01879
phone +1 978 649 0293
fax +1 978 649 0294
info.us@cab.de
www.cab.de/us

Latin America

Alejandro Balmaceda
Hacienda Jurica Pte 1615
Colonial de Valle
32553 Ciudad Juárez
phone +52 656 682 3745
fax +52 656 682 4301
a.balmaceda@cab.de
www.cab.de/es

Asia

Taiwan

cab Technology Co., Ltd.
希愛比科技股份有限公司
16F-1, No. 700, Jhong Jheng Rd
Junghe, Taipei 23552
phone +886 (02) 8227 3966
fax +886 (02) 8227 3566
info.asia@cab.de
www.cab.de/tw

China

cab (Shanghai) Trading Co., Ltd.
铠博(上海)贸易有限公司
A507, No. 268, Tong Xie Rd
Shanghai 200335
phone +86 (021) 6236 3161
fax +86 (021) 6236 3162
info.cn@cab.de
www.cab.de/cn

cab (Shanghai) Trading Co., Ltd.
铠博(上海)贸易有限公司
Room 39, 10F, 8 Lin He Zhong Rd
Tian He District, Guangzhou 510610
phone +86 (020) 2831 7358
info.cn@cab.de
www.cab.de/cn

Africa

South Africa

cab Technology (Pty) Ltd.
14 Republic Street
Bordeaux
2125 Randburg
phone +27 11 886 3580
fax +27 11 789 3913
info.za@cab.de
www.cab.de/za