

Stock Labels & Ribbons Price Book 2018

**WE WON'T
BE BEATEN
ON PRICE!**



Effective
February 2018

Weber
PACKAGING SOLUTIONS

Weber

PACKAGING SOLUTIONS

Weber's offering of high-performance, thermal-transfer labels is the answer to problem free labelling. Our general purpose labels satisfy numerous industrial applications, especially if you're labelling drums, packaging film, plastic, glass or metal. Weber also supplies compatible thermal-transfer ribbons for reliable, cost-effective printing.

Take a look at our stock labels featured here. If you don't see the size you require, don't worry - just email or call us with your requirements and we'll have a member of our sales team help you find a solution.

Our stock vellum labels are ideal for automotive bar coding, inventory control, work-in-progress and lower-temperature applications. The material combines a matte-coated, ultra-smooth paper facesheet with a permanent acrylic adhesive.



Weber Marking Systems UK headquarters

...and don't forget the ribbons!



WEBER PACKAGING SOLUTIONS:

Kilcannon Ind. Est., Old Dublin Road,
Enniscorthy, County Wexford, Ireland
Tel: 053 9233778
Fax: 053 9233284
sales@weberireland.com
www.webermarking.ie

WEBER PACKAGING SOLUTIONS:

Macmerry Industrial Estate, Tranent,
East Lothian. EH33 1HD
Tel: 01875 611 111
Fax: 01875 613 310
sales@weber.co.uk
www.weber.co.uk



COMPANY WITH
MANAGEMENT SYSTEM
CERTIFIED BY DNV GL
= ISO 9001 =
= ISO 14001 =

Thermal Transfer Ribbons

Choosing the correct one:

Weber's long experience with thermal-transfer print technologies and compatible label materials has given us a broad understanding of exactly which ribbon is best suited to your particular application. Our thermal-transfer ribbons operate with a wide variety of label printers and printer-applicators from today's leading manufacturers. Each ribbon is formulated to print high-density barcodes, text and graphics for product identification, work-in-progress, inventory control, shipping and other applications.

Easymark

Easymark is a premium wax grade, resin enhanced especially for maximum print performance. High carbon content guarantees a crisp, sharp black image - so crucial for the printing of graphics, text and barcodes. Manufactured with a hot melt or solvent based process, Wax ribbons will print at higher speeds and lower temperatures than wax resin or resin ribbons. Our wax thermal ribbons have been developed to provide maximum performance upon a broad range of coated and plain paper. Image density, edge definition and a low energy release combine to deliver a rock-solid solution for today's markets.

Duraprint

Duraprint grade of thermal ribbon is designed to work with flat head technology printers, providing perfect printer performance. Wax resin is a high-end solution, particularly suited to the high volume segment of labelling, providing versatility over a broad range of both film media and paper. Coated with a combination of wax and resin ink formulations, Wax Resin thermal ribbons offer more print durability than wax ribbons. Scratch and abrasion resistance is also superior to that of wax ribbons but inferior to full resin ribbons. Outstanding image density, edge definition and a low energy release deliver a solid, single source solution for today's markets

Ultraplate

Ultraplate ribbons are UL approved resin ribbon crafted to work with flat head thermal transfer printers operating in industrial conditions. Resin is another premium solution best suited where high durability is of paramount importance, offering exceptional versatility over an enormous range of synthetic and paper media. Manufactured with a pure resin coating, Resin ribbons have the highest degree of scratch and abrasion resistance and can withstand heat and most chemicals. Printing must be carried out at lower speeds and higher temperatures and the materials. Outstanding image density, edge definition and a low energy release delivers a solid solution for today's markets.

Please note: Where stronger, more abrasive chemicals are being used please ask about our extreme resin ribbons.

Colour Ribbons

Weber offers an array of colours in wax, wax/resin, and resin formulations for standard and near-edge printers. You can employ colour to improve the appearance of your packaging, streamline your operation with colour-coding, and aid in keeping your pre-printed label inventory to a minimum.

*Bar code scannability must be tested when using colour ribbons.

TTR108

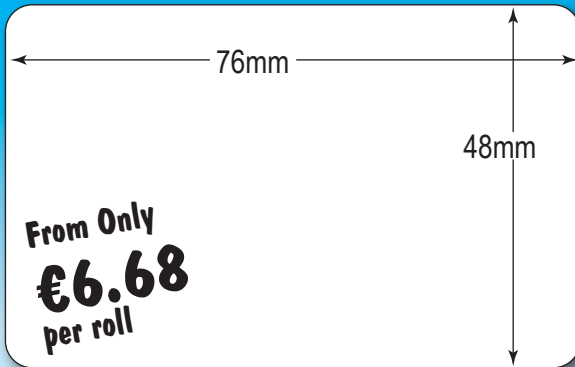

Label not to scale - for illustration purposes only.

1 Box	Up to 4 boxes
€69.16 <small>per box</small>	€66.18 <small>per box</small>
Up to 9 boxes	Up to 15 boxes
€62.92 <small>per box</small>	€61.30 <small>per box</small>
Up to 24 boxes	Up to 50 boxes
€59.67 <small>per box</small>	€56.96 <small>per box</small>
Up to 100 boxes	
€53.43 <small>per box</small>	

Excluding VAT & carriage. Prices subject to change.



Material: Vellum

Supplied one across on 76.2mm cores

Labels per roll: 3000

8 rolls per case

24000 labels per case

L-R-W PACK

All you need in one handy box.

Tired of purchasing labels and ribbons separately? Weber supply complete packs making it even easier to purchase Thermal Transfer media. See page 18 for prices



TTR116

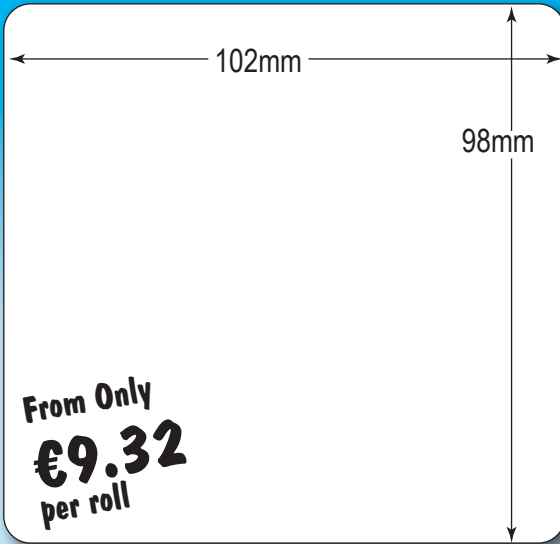

Label not to scale - for illustration purposes only.

1 Box	Up to 4 boxes
€48.21 <small>per box</small>	€45.97 <small>per box</small>
Up to 9 boxes	Up to 15 boxes
€43.80 <small>per box</small>	€42.72 <small>per box</small>
Up to 24 boxes	Up to 50 boxes
€41.63 <small>per box</small>	€39.67 <small>per box</small>
Up to 100 boxes	
€37.23 <small>per box</small>	

Excluding VAT & carriage. Prices subject to change.



Material: Vellum

**Supplied one across
on 76.2mm cores**

Labels per roll: 1500

4 rolls per case

6000 labels per case

NEED LABELS IN A HURRY ?

Weber's Internal label bureau service can provide you with cost effective labels from our selected number of stock labels. Our service includes printing onto blank or part pre-printed labels. This service is ideal for barcode, variable data and sequential numbering including consecutive barcodes. Whether you just require a small quantity of labels or you have lots of variable information labels Weber can produce to your needs.



TTR127

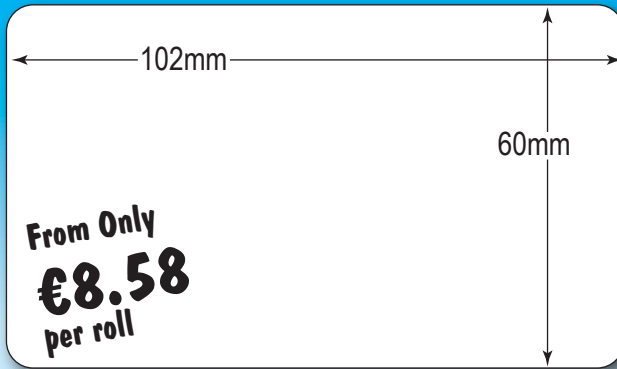

Label not to scale - for illustration purposes only.



1 Box	Up to 4 boxes
€44.39 <small>per box</small>	€42.31 <small>per box</small>
Up to 9 boxes	Up to 15 boxes
€40.35 <small>per box</small>	€39.29 <small>per box</small>
Up to 24 boxes	Up to 50 boxes
€38.36 <small>per box</small>	€36.49 <small>per box</small>
Up to 100 boxes	
€34.31 <small>per box</small>	

Excluding VAT & carriage. Prices subject to change.

Material: Vellum

Supplied one across on 76.2mm cores

Labels per roll: 2300

4 rolls per case

9200 labels per case



PRE-PRINTED LABELS

The quality of your labels say a great deal about the product and the company it identifies. We use state-of-the-art flexographic and digital presses to manufacture high-quality pressure-sensitive labels and RFID labels for thousands of companies. We also supply compatible thermal-transfer ribbons to maximize the print quality of your labels.

For more information call: 053 9233778

TTR129



Label not to scale - for illustration purposes only.

1 Box	Up to 4 boxes
€45.56 <small>per box</small>	€43.48 <small>per box</small>
Up to 9 boxes	Up to 15 boxes
€41.40 <small>per box</small>	€40.41 <small>per box</small>
Up to 24 boxes	Up to 50 boxes
€39.33 <small>per box</small>	€37.43 <small>per box</small>
Up to 100 boxes	
€35.17 <small>per box</small>	

Excluding VAT & carriage. Prices subject to change.



Material: Vellum

Supplied one across on 76.2mm cores

Labels per roll: 2000

4 rolls per case

8000 labels per case

INTEGRATED LABELLING SOLUTIONS

We provide integrated labelling solutions that are uniquely engineered to streamline specific product identification and handling operations.

Companies in virtually every industry have utilised Weber's wide range of integrated systems. Each is uniquely engineered to address a specific application, yet flexible enough to fit seamlessly into an existing packaging line.

For more information call: 053 9233778

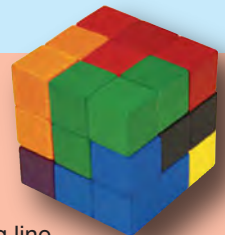

TTR1362

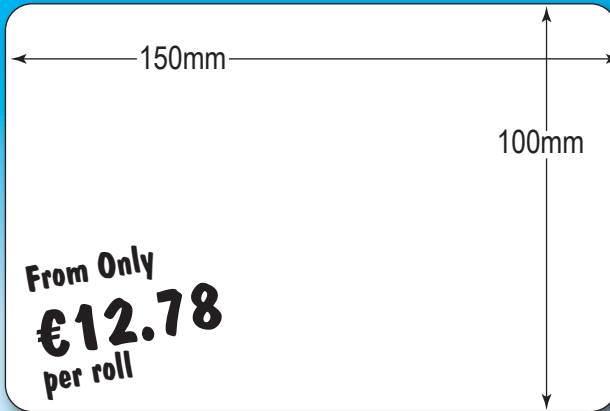

Label not to scale - for illustration purposes only.

1 Box	Up to 4 boxes
€66.20 <small>per box</small>	€63.18 <small>per box</small>
Up to 9 boxes	Up to 15 boxes
€60.16 <small>per box</small>	€58.66 <small>per box</small>
Up to 24 boxes	Up to 50 boxes
€57.15 <small>per box</small>	€54.47 <small>per box</small>
Up to 100 boxes	
€59.64 <small>per box</small>	

Excluding VAT & carriage. Prices subject to change.



Material: Vellum

Supplied one across on 76.2mm cores

Labels per roll: 1450

4 rolls per case

5800 labels per case

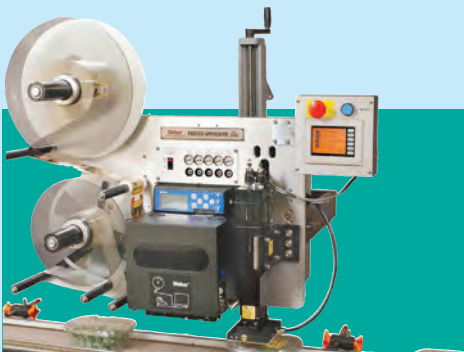

5300 PRINTER/APPLICATOR

High-resolution printing and high-speed operation combined with a diverse selection of label application methods.

For more information call: 053 9233778

TTR140



Label not to scale - for illustration purposes only.



1 Box	Up to 4 boxes
€53.70 <small>per box</small>	€51.53 <small>per box</small>
Up to 9 boxes	Up to 15 boxes
€48.82 <small>per box</small>	€47.73 <small>per box</small>
Up to 24 boxes	Up to 50 boxes
€46.65 <small>per box</small>	€43.93 <small>per box</small>
Up to 100 boxes	
€41.76 <small>per box</small>	

Excluding VAT & carriage. Prices subject to change.

Material: Vellum

**Supplied one across
on 76.2mm cores**

Labels per roll: 6000

8 rolls per case

48000 labels per case

Blink and you'll miss it !

When it comes to industrial inkjet printing, Weber's reputation is second to none. Our continuous ink jet printers, laser coders and large character printers are used on production lines across the United Kingdom and Ireland helping manufacturing sectors, including the food, beverage, pharmaceutical, cosmetics, automotive and electronic industries, where product identification codes, batch numbers, use by dates and barcodes are required.



For more information call: 053 9233778

The simple solution

If you use one of these:



+ Then you're gonna need some of these:



+ and some of these:



The answer = **Weber**
PACKAGING SOLUTIONS

Do you have a label printer ?
Buying consumables for it is *simple*.
Simply call Weber and let us find a *simple* , cost effective
solution for your label printing requirements. **Simple**.

Call to discuss your requirements on: 053 9233778
Quoting "SIMPLE" and receive **FREE** next day delivery.

Printhead Cleaning Made Easy

No Mess - No Waste - No Fuss !



Keep Thermal Printheads Clean!

In bar code printers, the main cause of premature printhead failure is a buildup of adhesive, label residue and other contaminants.

This creates a baked-on coating that heat produced by the printhead cannot penetrate. The trapped heat burns out the dots. With bar code thermal printers, failure of only two dots can render the printhead useless.

End user maintenance has a direct and dramatic effect on the productive life of a printhead. According to a leading thermal printer manufacturer, a maintenance program can decrease printhead failures by 80%. In addition to guarding against dot failure, cleaning printheads on a regular basis helps prevent or eliminate repetitive voids in bar code images.

Cleaning should be convenient for operators and scheduled at consistent intervals (for example, when you change label or ticket stock). Weber provides three presaturated products to clean thermal printheads.

The **Thermalcard**, **Thermalpen** and **Thermalwipe**. The concept behind presaturated cleaning supplies is simple: the easier it is for operators to clean printheads, the more likely it is they will do it regularly.

Thermalwipe	100 / Box	€22.03 (per box)
Thermalcard	25 / Box	€15.82 (per box)
Thermalpen	12 / Box	€11.30 (per box)

All prices are exclusive of VAT & delivery. Terms & Conditions are available on request.

Near Edge Ribbons



Ink Coating INSIDE - Suitable for Smartdate printers (cardboard code)

Stock Code	Ribbon Size	Product Code	Stocked Item	Ribbons per box	1 - 199 ribbons	200 - 499 ribbons	500+ ribbons
SD2/3035600	35mm x 600m	B112	NO	40	€3.12	€2.99	€2.93
SD2/3045600	40mm x 600m	B112	NO	30	€3.56	€3.42	€3.35
SD2/3055600	55mm x 600m	B112	NO	30	€4.89	€4.70	€4.61

Ink Coating INSIDE - Suitable for Smartdate printers (plastic code)

Stock Code	Ribbon Size	Product Code	Stocked Item	Ribbons per box	1 - 199 ribbons	200 - 499 ribbons	500+ ribbons
SD2/3025600P	25mm x 600m	B112	NO	50	€2.23	€2.14	€2.09
SD2/3035600P	35mm x 600m	B112	NO	40	€3.12	€2.99	€2.93
SD2/3050600P	50mm x 600m	B112	NO	30	€4.45	€4.27	€4.19
SD2/3055600P	55mm x 600m	B112	NO	30	€4.89	€4.70	€4.61

Ink Coating INSIDE - Suitable for Smartdate printers (plastic code)

HI-SPEED

Stock Code	Ribbon Size	Product Code	Stocked Item	Ribbons per box	1 - 199 ribbons	200 - 499 ribbons	500+ ribbons
SD2/HS035600	35mm x 600m	P110	NO	40	€3.27	€3.13	€3.07
SD2/HS055600	55mm x 600m	P110	NO	30	€5.13	€4.93	€4.83

Ink Coating INSIDE - Suitable for Smartdate printers (plastic code)

HI-SPEED WHITE

Stock Code	Ribbon Size	Product Code	Stocked Item	Ribbons per box	1 - 199 ribbons	200 - 499 ribbons	500+ ribbons
SD23035600PW	35mm x 600m	P110W	NO	40	€8.90	€8.54	€8.37
SD23035600PW	55mm x 600m	P110W	NO	30	€13.99	€13.42	€13.16

Ink Coating OUTSIDE - Suitable for Ice coders (plastic code)

Stock Code	Ribbon Size	Product Code	Stocked Item	Ribbons per box	1 - 199 ribbons	200 - 499 ribbons	500+ ribbons
ICE0301000	30mm x 1000m	B112	NO	32	€4.45	€4.27	€4.19
ICE0551000	55mm x 1000m	B112	NO	24	€8.16	€7.83	€7.67
ICE100600	100mm x 600m	B112	NO	10	€8.90	€8.54	€8.37

Ink Coating OUTSIDE - Suitable for Ice coders (plastic code)

HI-SPEED

Stock Code	Ribbon Size	Product Code	Stocked Item	Ribbons per box	1 - 199 ribbons	200 - 499 ribbons	500+ ribbons
ICE0301000HS	30mm x 1000m	P110	NO	32	€4.67	€4.47	€4.38
ICE0551000HS	55mm x 1000m	P110	NO	24	€8.54	€8.20	€8.05
ICE100600HS	100mm x 600m	P110	NO	10	€9.32	€8.95	€8.77

Ink Coating OUTSIDE - Suitable for Ice coders (plastic code)

HI-SPEED WHITE

Stock Code	Ribbon Size	Product Code	Stocked Item	Ribbons per box	1 - 199 ribbons	200 - 499 ribbons	500+ ribbons
ICE0551000PW	55mm x 1000m	P110W	NO	24	€23.31	€22.37	€21.93

Ink Coating OUTSIDE - Suitable for TEC Printers (Models: EX4, SX4 & SX5)

Stock Code	Ribbon Size	Product Code	Stocked Item	Ribbons per box	1 - 199 ribbons	200 - 499 ribbons	500+ ribbons
T056600EC	56mm x 600m	B112	NO	20	€5.22	€5.02	€4.92
T068600EC	68mm x 600m	B112	NO	20	€6.34	€6.09	€5.97
T076600EC	76mm x 600m	B112	NO	20	€7.09	€6.80	€6.67
T084600EC	84mm x 600m	B112	NO	20	€7.83	€7.51	€7.37
T089600EC	89mm x 600m	B112	NO	10	€8.29	€7.97	€7.81
T102600EC	102mm x 600m	B112	NO	10	€9.51	€9.13	€8.95
T110600EC	110mm x 600m	B112	NO	10	€10.26	€9.84	€9.65
T114600EC	114mm x 600m	B112	NO	10	€10.63	€10.20	€10.00
T134600EC	134mm x 600m	B112	NO	10	€12.50	€11.99	€11.75

Ink Coating OUTSIDE - Suitable for TEC Printers (Models: EX6 & SX8)

Stock Code	Ribbon Size	Product Code	Stocked Item	Ribbons per box	1 - 199 ribbons	200 - 499 ribbons	500+ ribbons
T115300EC	115mm x 300m	B112	NO	16	€5.36	€5.14	€5.04
T138300EC	138mm x 300m	B112	NO	16	€6.43	€6.17	€6.06
T160300EC	160mm x 300m	B112	NO	16	€7.46	€7.16	€7.02
T176300EC	176mm x 300m	B112	NO	16	€8.20	€7.88	€7.72
	220mm x 300m	B112	NO	16	€10.26	€9.84	€9.65

FREE SERVICE CHECK

We will give you:

FREE

Barcode/text visual check

FREE

Advice on improvements

FREE

On-site Survey

Weber can offer you help on labels and labelling equipment and consumables as well as service support on all leading printers including: Zebra, Datamax and Sato.

To get your **FREE** on-site survey simply call our Service Dept on: 053 9233778 and quote:

2018FREECHECKER

Weber

PACKAGING SOLUTIONS



We
stick
to *your*
promises.

WEBER MARKING SYSTEMS: Macmerry Industrial Estate, Tranent, East Lothian. EH33 1HD

Tel: 01875 611 111 • Fax: 01875 613 310 • sales@weber.co.uk • www.weber.co.uk

WEBER LABELLING & CODING: Kilcannon Ind. Est., Old Dublin Road, Enniscorthy, County Wexford, Ireland

Tel: 053 9233778 • Fax: 0353 9233284 • sales@weberireland.com • www.weberireland.com



NEW



L-R-W PACK LABELS RIBBONS WIPES

Need a simple solution? Buying everything you need in one simple box

Our **L-R-W PACKS** contain everything you require to print all your label requirements. We supply premium quality top coated thermal transfer labels along with wax or wax/resin outside wound ribbons allowing you to produce labels for a wide range of applications including:

Address labels - Product labels - Barcode labels

Along with your labels and ribbons you'll receive cleaning wipes to maintain and keep your printhead in optimum condition.

Available in the following label size options:

FREE
DELIVERY**

LRW Stock Code	Core Size	Label Width	Label Depth	No. of Labels	Ribbon	Price
LRW143EM	76.2mm	38mm	25mm	16,050	Wax	€20.28
LRW140EM	76.2mm	51mm	22mm	18,000	Wax	€24.80
LRW108EM	76.2mm	76mm	48mm	9,000	Wax	€30.45
LRW173EM	76.2mm	76mm	149mm	3,000	Wax	€30.45
LRW148EM	76.2mm	102mm	48mm	9,000	Wax	€38.36
LRW127EM	76.2mm	102mm	60mm	6,900	Wax	€38.36
LRW129EM	76.2mm	102mm	73mm	6,000	Wax	€38.36
LRW116EM	76.2mm	102mm	98mm	4,500	Wax	€38.36
LRW170EM	76.2mm	102mm	149mm	3,000	Wax	€38.36
LRW216EM	76.2mm	127mm	48mm	9,000	Wax	€48.53
LRW1362EM	76.2mm	150mm	100mm	4,350	Wax	€53.05
LRW76Z	25.4mm	102mm	76mm	2,970	Wax	€51.92
LRW102Z	25.4mm	102mm	102mm	2,100	Wax	€51.92
LRW152Z	25.4mm	102mm	152mm	1,425	Wax	€51.92

** Standard two day delivery - excluding weekends

LIMITED OFFER

For a limited time only we are including our **Legitronic Labelling Software***. Allowing you to produce anything from simple line and text labels to barcode and graphics with database integration.

* Single label printing only, dongle purchase is required for mass label production.



TTR143

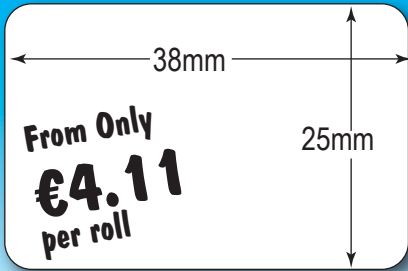

Label not to scale - for illustration purposes only.



1 Box	Up to 4 boxes
€42.55 <small>per box</small>	€40.62 <small>per box</small>
Up to 9 boxes	Up to 15 boxes
€38.69 <small>per box</small>	€37.72 <small>per box</small>
Up to 24 boxes	Up to 50 boxes
€40.15 <small>per box</small>	€34.83 <small>per box</small>
Up to 100 boxes	
€32.88 <small>per box</small>	

Material: Vellum

**Supplied one across
on 76.2mm cores**

Labels per roll: 5350

8 rolls per case

42800 labels per case

Excluding VAT & carriage. Prices subject to change.



You Tube

Find us on:

facebook

Linked in

TTR143-2

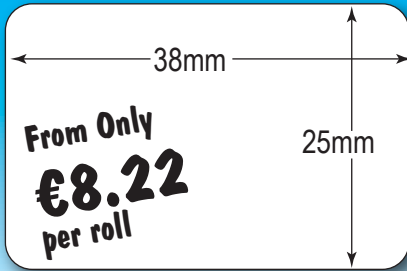

Label not to scale - for illustration purposes only.



1 Box	Up to 4 boxes
€42.56 <small>per box</small>	€68.20 <small>per box</small>
Up to 9 boxes	Up to 15 boxes
€38.69 <small>per box</small>	€63.36 <small>per box</small>
Up to 24 boxes	Up to 50 boxes
€40.15 <small>per box</small>	€58.52 <small>per box</small>
Up to 100 boxes	
€32.88 <small>per box</small>	

Material: Vellum

Supplied two across on 76.2mm cores

Labels per roll: 10700

4 rolls per case

42800 labels per case

Excluding VAT & carriage. Prices subject to change.

PALLET LABELLING ?

Continuous or stationary pallet labelling: the modular LEGI-AIR 4050 P is specifically designed for these tasks. The system offers further advantages with regard to speed, security, fields of application, size and ease of servicing.

For more information call: 053 9233778



TTR147

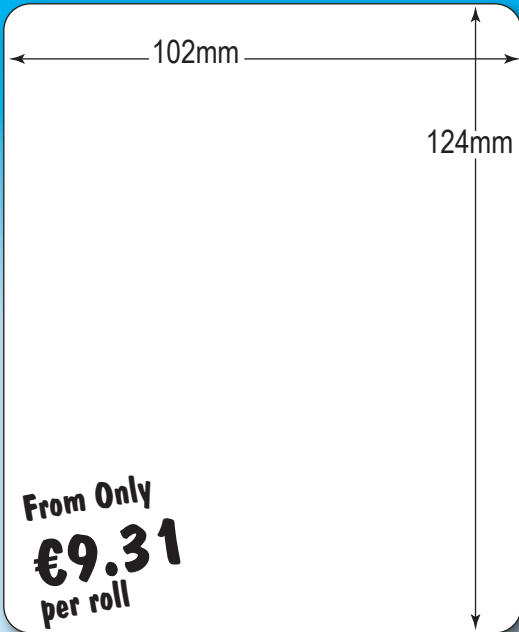

Label not to scale - for illustration purposes only.

1 Box	Up to 4 boxes
€48.22 <small>per box</small>	€45.99 <small>per box</small>
Up to 9 boxes	Up to 15 boxes
€43.82 <small>per box</small>	€42.74 <small>per box</small>
Up to 24 boxes	Up to 50 boxes
€41.65 <small>per box</small>	€39.65 <small>per box</small>
Up to 100 boxes	
€37.27 <small>per box</small>	

Excluding VAT & carriage. Prices subject to change.



Material: Vellum

**Supplied one across
on 76.2mm cores**

Labels per roll: 1200

4 rolls per case

4800 labels per case

DESKTOP PRINTERS

Zebra's best-in-class Z Series printers just got better! The ZT400 Series RFID printer/ encoders pair UHF RFID capabilities with proven durability to help keep your critical operations running efficiently. Known as price-performance leaders in RFID labelling, the ZT400 Series RFID supports a broad range of applications across several industries.

For more information call: 053 9233778



TTR148



Label not to scale - for illustration purposes only.



1 Box	Up to 4 boxes
€48.27 <small>per box</small>	€46.10 <small>per box</small>
Up to 9 boxes	Up to 15 boxes
€43.93 <small>per box</small>	€42.85 <small>per box</small>
Up to 24 boxes	Up to 50 boxes
€41.76 <small>per box</small>	€39.73 <small>per box</small>
Up to 100 boxes	
€37.29 <small>per box</small>	

Material: Vellum

Supplied one across on 76.2mm cores

Labels per roll: 3000

4 rolls per case

12000 labels per case

Excluding VAT & carriage. Prices subject to change.

Alpha Compact Label Applicator

Weber's Alpha Compact label applicator is a cost effective solution to fast, reliable pressure-sensitive labelling. This system features a small footprint, yet employs a highly-accurate wipe-on method of application to affix p-s labels on the production line.

For more information call: 053 9233778

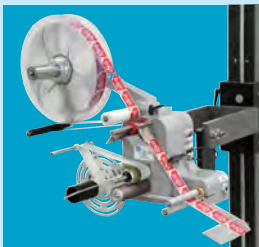

TTR164

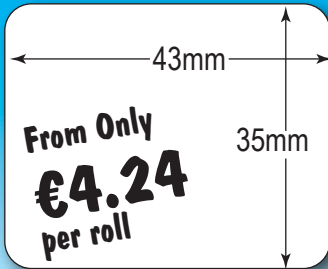

Label not to scale - for illustration purposes only.



1 Box	Up to 4 boxes
€43.92 <small>per box</small>	€42.14 <small>per box</small>
Up to 9 boxes	Up to 15 boxes
€39.99 <small>per box</small>	€38.92 <small>per box</small>
Up to 24 boxes	Up to 50 boxes
€37.86 <small>per box</small>	€36.07 <small>per box</small>
Up to 100 boxes	
€33.92 <small>per box</small>	

Material: Vellum

**Supplied one across
on 76.2mm cores**

Labels per roll: 3950

8 rolls per case

31600 labels per case

Excluding VAT & carriage. Prices subject to change.



You Tube

Find us on:

facebook

Linked in

TTR216

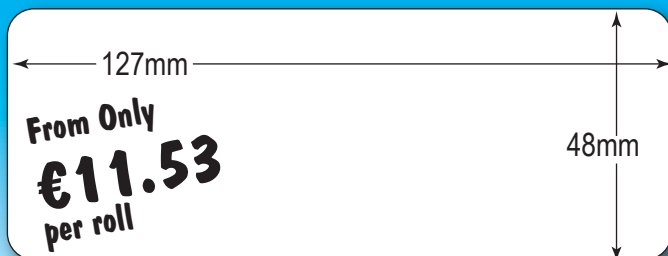

Label not to scale - for illustration purposes only.



1 Box	Up to 4 boxes
€59.66 <small>per box</small>	€56.95 <small>per box</small>
Up to 9 boxes	Up to 15 boxes
€54.24 <small>per box</small>	€52.88 <small>per box</small>
Up to 24 boxes	Up to 50 boxes
€51.53 <small>per box</small>	€49.09 <small>per box</small>
Up to 100 boxes	
€46.10 <small>per box</small>	

Excluding VAT & carriage. Prices subject to change.

Material: Vellum

**Supplied one across
on 76.2mm cores**

Labels per roll: 3000

4 rolls per case

12000 labels per case

PALLET LABELLING ?

Continuous or stationary pallet labelling: the modular LEGI-AIR 4050 P is specifically designed for these tasks. The system offers further advantages with regard to speed, security, fields of application, size and ease of servicing.

For more information call: 053 9233778



TTR173



Label not to scale - for illustration purposes only.



Material: Vellum

Supplied one across on 76.2mm cores

Labels per roll: 1000

8 rolls per case

8000 labels per case

1 Box	Up to 4 boxes
€68.79 <small>per box</small>	€65.72 <small>per box</small>
Up to 9 boxes	Up to 15 boxes
€62.56 <small>per box</small>	€61.02 <small>per box</small>
Up to 24 boxes	Up to 50 boxes
€59.39 <small>per box</small>	€56.59 <small>per box</small>
Up to 100 boxes	
€53.16 <small>per box</small>	

Excluding VAT & carriage. Prices subject to change.

DESKTOP PRINTERS

Zebra's best-in-class Z Series printers just got better! The ZT400 Series RFID printer/ encoders pair UHF RFID capabilities with proven durability to help keep your critical operations running efficiently. Known as price-performance leaders in RFID labelling, the ZT400 Series RFID supports a broad range of applications across several industries.

For more information call: 053 9233778



TTR184

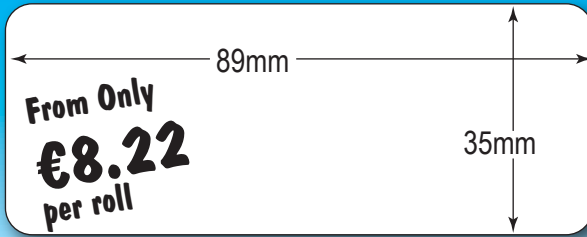

Label not to scale - for illustration purposes only.



1 Box	Up to 4 boxes
€42.49 <small>per box</small>	€40.53 <small>per box</small>
Up to 9 boxes	Up to 15 boxes
€38.57 <small>per box</small>	€43.56 <small>per box</small>
Up to 24 boxes	Up to 50 boxes
€38.39 <small>per box</small>	€34.82 <small>per box</small>
Up to 100 boxes	
€32.85 <small>per box</small>	

Excluding VAT & carriage. Prices subject to change.

Material: Vellum

Supplied one across on 76.2mm cores

Labels per roll: 3950

4 rolls per case

15800 labels per case

L-R-W
PACK
LABELS RIBBONS WIPES

All you need in one handy box.

Tired of purchasing labels and ribbons separately? Weber supply complete packs making it even easier to purchase Thermal Transfer media. See page 18 for prices



TTR170

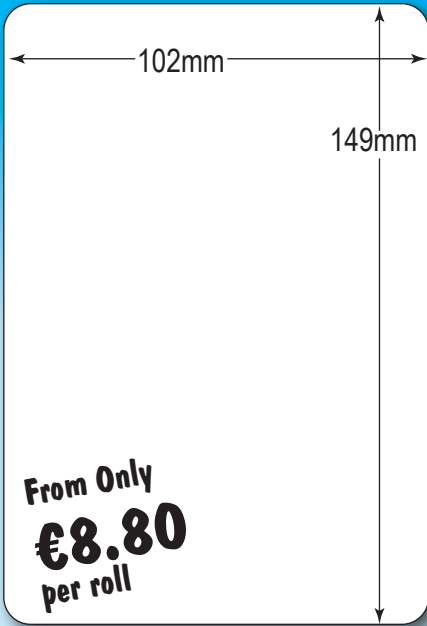

Label not to scale - for illustration purposes only.



Material: Vellum

Supplied one across on 76.2mm cores

Labels per roll: 1000

4 rolls per case

4000 labels per case

1 Box	Up to 4 boxes
€45.56 <small>per box</small>	€43.48 <small>per box</small>
Up to 9 boxes	Up to 15 boxes
€41.40 <small>per box</small>	€40.36 <small>per box</small>
Up to 24 boxes	Up to 50 boxes
€39.32 <small>per box</small>	€37.47 <small>per box</small>
Up to 100 boxes	
€35.21 <small>per box</small>	

Excluding VAT & carriage. Prices subject to change.



Find us on:

facebook



Weber

PACKAGING SOLUTIONS

**Pre-Printed &
Blank Labels**

**Ink Jet Coding
Systems**

**Barcode &
Traceability**

**Thermal Transfer
Ribbons**

**Desktop
Printers**

**Label & Printer
Applicators**

Consultancy

Bar Coding

Software



Weber's broad line of label printing solutions utilises the foremost printing technologies to simplify on-site, industrial labelling. Our selection of thermal-transfer and direct-thermal systems offers label printing solutions for virtually any application. In addition, Weber provides RFID smart label printer/encoders to help comply with the RFID supply chain requirements of major retailers and government agencies. Our printers and printer/encoders permit the printing of high-quality bar codes, text and graphic images in demand and batch modes.

*If we can help you with any of your labelling requirements please contact us by calling: **053 9233778** or email: sales@weberireland.com*